

# EXCELPellet

PELLET AND BIOFUEL VENTING SYSTEM



## EXCELPellet Technical Information

### Certification

EXCELPellet has been tested and listed to UL 641 and ULC S609 by Intertek Testing Services.

### Applications

EXCELPellet is certified as a chimney liner for use on appliances that burn:

- Wood
- Agricultural products
- Natural or LP Gas

### Allowable Flue Gas Temperatures

Max Continuous	300°C (572°F)
Tested To	927°C (1700 °F)

### Clearance to Combustible Materials

EXCELPellet is certified for 1" clearance to combustible materials.

### Construction

**Flue:** .016" laser welded stainless steel.

**Casing:** .019" laser welded Galvalume steel or .019" laser welded satin coat steel (painted)

**Paint:** Forrest "Stove Bright" *flat black*.

**Insulation:** 3/8" Air Space

**Gasket:** Silicone Rubber

## EXCELPellet Engineering and Design Considerations

We suggest that your pellet system be designed with a vertical rise. This is not a requirement but will help the stove to vent combustion products in the case of a power failure.

Keeping the horizontal run and number of elbows to a minimum will reduce the cost of your installation and improve performance.

Although not required we recommend that terminations be installed 12" away from the wall to reduce the potential for smoke stain on outside walls. Refer to your stove manual for exact dimensions.

Do not install a vent smaller in diameter than the flue outlet on the stove.

EXCELPellet must be installed according to the installation instructions (available from your dealer upon purchase of support or on our web site).

EXCELPellet is manufactured using specialized machinery which makes it possible to maintain strict tolerances between components. This precision permits the use of a factory installed silicone gasket and eliminates the need for field application of silicone.

This unique factory installed silicone rubber gasket solves two major pellet venting problems:

- The gasket seals perfectly so there is no need for sealant application in the field. This speeds up installation, simplifies clean up, facilitates painting and eliminates callbacks.
- Not only do all parts assemble easily, they can be disassembled and reassembled just as easily making routine maintenance much easier.

EXCELPellet has a smooth attractive Black painted or Galvalume steel exterior. Galvalume is corrosion resistant and requires very little preparation for painting.



**Intertek**  
4005717

# EXCELPellet Typical Installations

*NOTE: The following information is provided to assist you in selecting the chimney components required for your installation. It is intended to be a guideline only. These are not the installation instructions.*

All measurements are in inches

Inside Diameter	3 Inch	4 Inch
Outside Diameter	3 3/4"	4 3/4"
Weight/Foot (lb/ft.)	1.3	1.6
Rough Opening Required:		
Supports (PSA, PSF)	5 3/4" x 5 3/4"	6 3/4" x 6 3/4"
Supports (PSS)	6 3/4" x 6 3/4"	6 3/4" x 6 3/4"
Wall Thimble (PWT)	6 1/2" x 6 1/2" or 6 1/2" round	7 1/2" x 7 1/2" or 7 1/2" round
Masonry Chimney Adapter (PAM)	6" to 8" dia.	6" to 8" dia.
Maximum Support capacity		
Ceiling Supports (PSA, PSF)	30 feet	25 feet
Ceiling Support (PSS)	37 feet	30 feet
Wall Support (PSW)	21 feet	17 feet

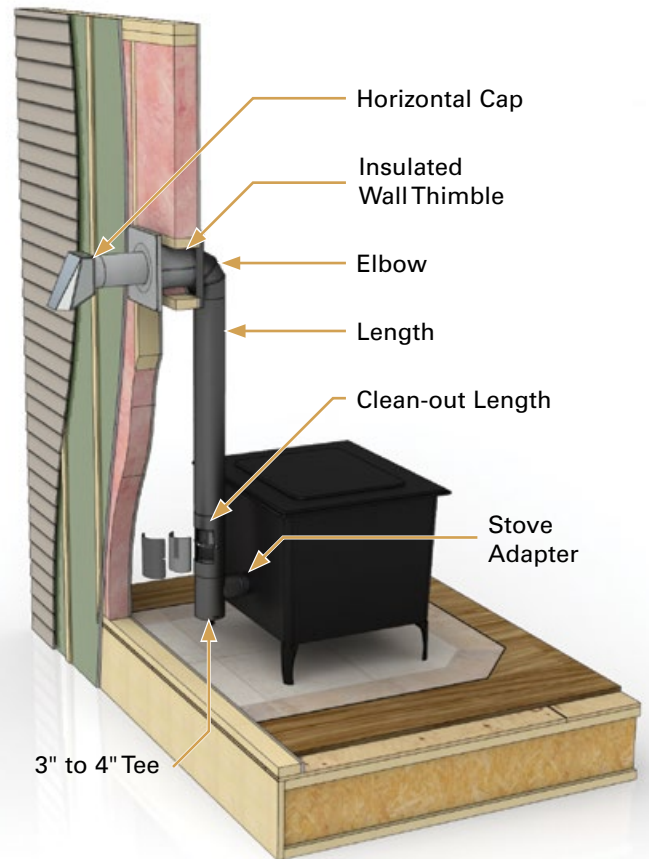
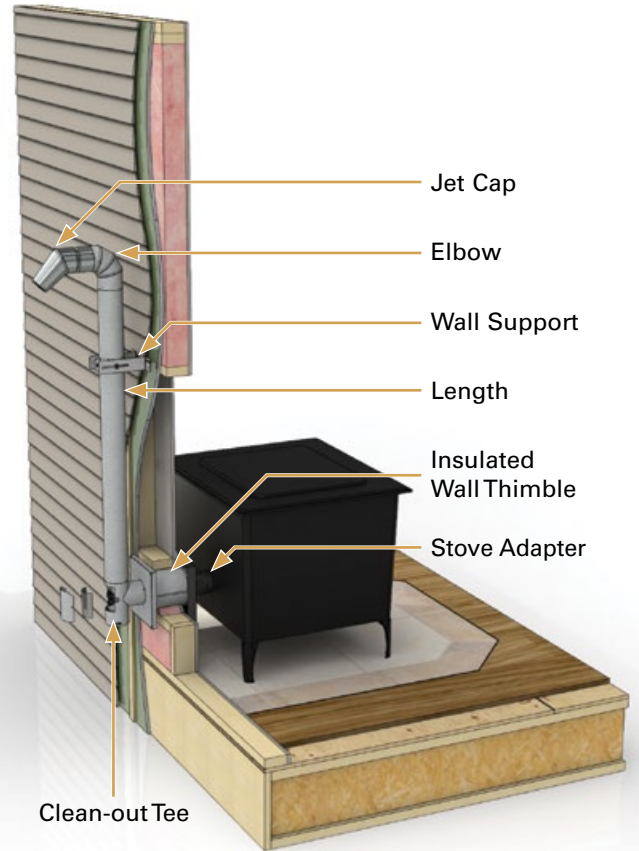
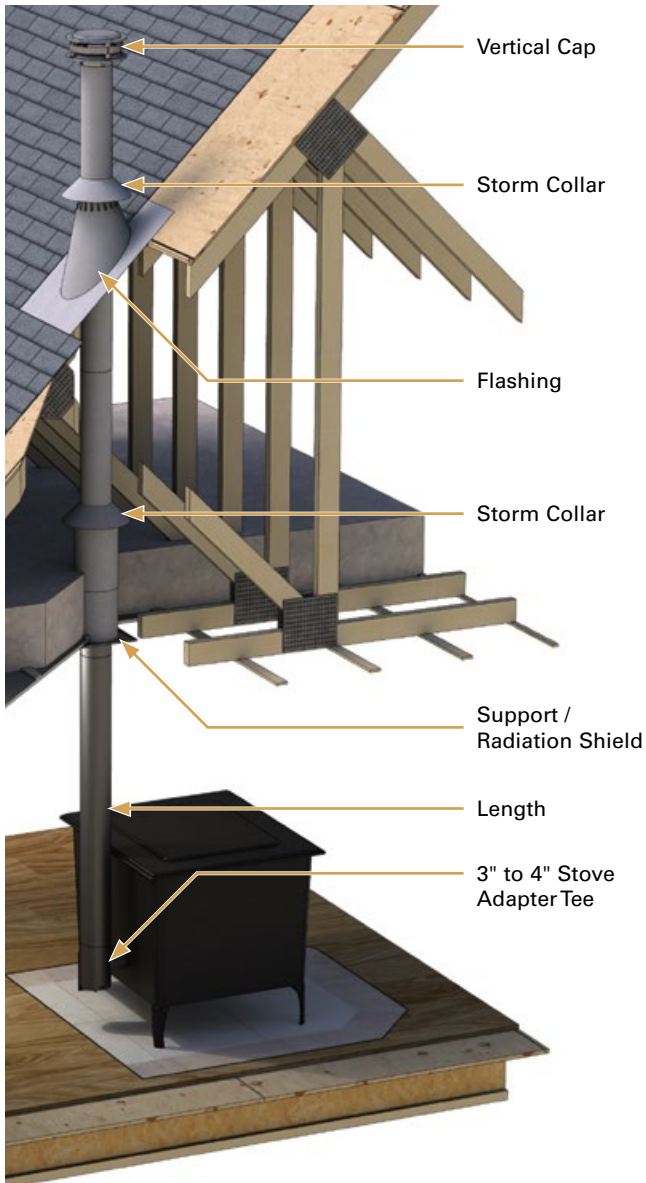

# EXCELPellet Product Descriptions

## Lengths

(PL5, PL5B, PLA6, PLA6B, PL16, PL16B, PLA16, PLA16B, PL1, PL1B, PL2, PL2B, PL3, PL3B, PL4, PL4B)

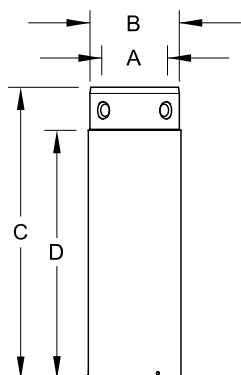

48", 36", 24", 16", 12", 5" & 6", 16" slip lengths, all lengths are available in Galvalume or Black exterior. Slip sections slide over standard length pellet vent.

INCHES

Length Dimensions						
	3"	4"				
A	3	4				
B	3 3/4	4 3/4				
Lengths	5"	12"	16"	24"	36"	48"
C	4 7/8	11 7/8	15 7/8	23 7/8	35 7/8	47 7/8
D	3 1/8	10 1/8	14 1/8	22 1/8	34 1/8	46 1/8
6" & 16" Slip Length Dimensions						
	3"		4"			
A	2 7/8		3 7/8			
B	3 7/8		4 7/8			
Lengths	6"		16"		16"	
C	7 3/4		15 3/4		15 3/4	
D	6		14		14	

## Clean-Out Length

(PCOL)

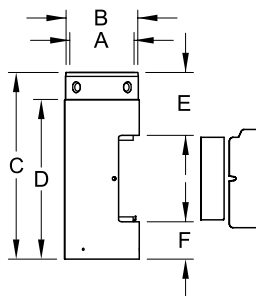

The removable casing allows access to the inside of the flue for easy cleaning. The Clean-Out length can be in any location as a substitute for a standard length.

INCHES

Clean-Out Length Dimensions		
	3"	4"
A	3 1/16	4 1/16
B	3 5/8	4 5/8
C	11 7/8	11 7/8
D	10 1/8	10 1/8
E	4 3/16	4 1/8
F	3 3/16	2 1/2

## Tees

(PT, PTB, 3PT4, 3PT4B)

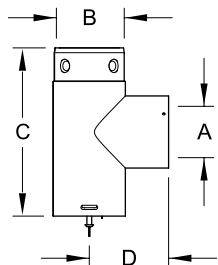

The tee cap incorporates a silicone gasket making it easy to remove for cleaning. All tees are available in Galvalume or Black exterior. Short snout places vent closer to stove. Tee cap included.

INCHES

Tee Dimensions			
	3"	4"	3" to 4"
A	3	4	3
B	3 3/4	4 3/4	4 3/4
C	8 3/4	9 3/4	8 3/4
D	4 1/8	4 5/8	4 5/8

## Stove Adapter Tee

(3PAT3, 3PAT3B, 3PAT4, 3PAT4B)

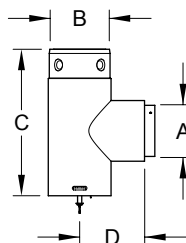

Stove Adapter Tees can be installed directly to the stove without the need for a stove adapter. Tee cap included.

INCHES

Stove Adapter Tee Dimensions		
	3"	3" to 4"
A	3	3
B	3 3/4	4 3/4
C	8 3/4	8 3/4
D	3 7/8	4 3/8
E	5/8	5/8

### Clean-Out Tee (PCOT)

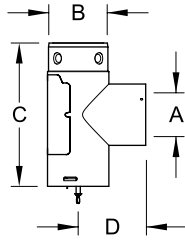

Allows easy access to the horizontal run of a system for cleaning. Tee cap included.

INCHES

Clean Out Tee Dimensions		
	3"	4"
A	3	4
B	3 3/4	4 3/4
C	8 3/4	9 3/4
D	4 1/8	4 5/8

### Tee Cap (PTC1)



PTC1

The PTC1 is a replacement tee cap held with a bolt at the bottom of the cap.

### Elbows (PE45, PE45B, PE90, PE90B)

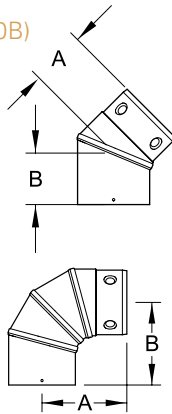

Small radius elbows make installations in tight spaces easier. 45° and 90° available, all elbows are available in Galvalume or Black exterior.

INCHES

Dimensions		
	A	B
3PE45	2 7/8	2 7/8
4PE45	3	3
3PE90	4 11/16	4 11/16
4PE90	5 1/4	5 1/4

### Slip Elbow (PE90S, PE90SB)

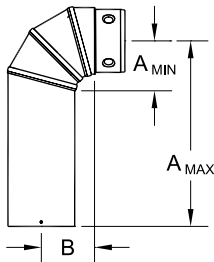

The vertical portion of the slip elbow slides over a standard pellet length just like a slip section. This eliminates the need for a separate slip piece.

INCHES

Dimensions			
Code	A max.	A min.	B
3PE90S	10 3/4	2 7/8	3
4PE90S	11 1/4	3 3/8	3 1/2

### Clean-Out Elbow (PCOE)

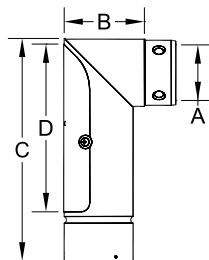

The removable casing allows access to the inside of the flue for easy cleaning. Typically used for "up and out" installations.

INCHES

Dimensions		
	3"	4"
A	3	4
B	4 1/2	5 1/2
C	12 3/8	13 3/8
D	9 3/8	9 7/8

### 3" - 4" Tapered Increaser (3PIT4, 3PIT4B)

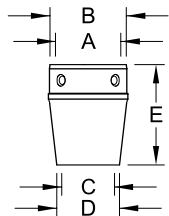

Used for increasing the diameter from 3" to 4" at any point in the system.

Dimensions		INCHES
A	4	
B	4 3/4	
C	3	
D	3 5/8	
E	6	

### Insulated Wall Thimble (PWT)

(PWT)

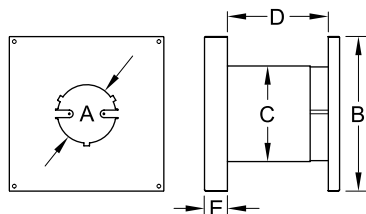
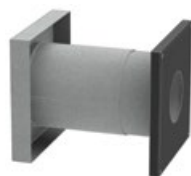

Telescopes to accommodate wall thicknesses from 5" to 10". It is fully insulated to maintain insulation integrity and fits tightly to prevent heat loss. The 3" requires a 6 1/2" X 6 1/2" framed opening; the 4" requires a 7 1/2" X 7 1/2" framed opening. A template for EXCELPellet wall thimbles can be purchased to simplify installation (PTMP).

Dimensions			INCHES
	3"	4"	
A	3 7/8	4 7/8	
B	9 1/4	10 1/4	
C	6 3/8	7 3/8	
D	min. 5 - max. 10		
E	1 1/2	1 1/2	

### Wall Thimble with Integrated Outside Air (PWTOI)

(PWTOI)

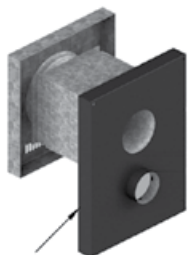

Insulated

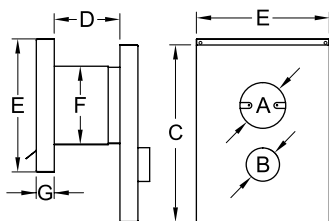

Simplifies a fresh air connection by integrating it into the same conduit as the wall thimble. This component is fully insulated through the wall and on the inside wall to prevent cold air or condensation in the home. Includes 10' of aluminum flex and 3' flex insulation.

Dimensions			INCHES
	3"	4"	
A	3 7/8	4 7/8	
B	2 7/8	2 7/8	
C	15	16	
D	min. 6 1/2 - max. 11 1/2		
E	11 1/4	12 1/4	
F	6 5/8	7 5/8	
G	1 1/2	1 1/2	

### Wall Thimble with Outside Air Channel (PWTOC)

(PWTOC)



Insulated

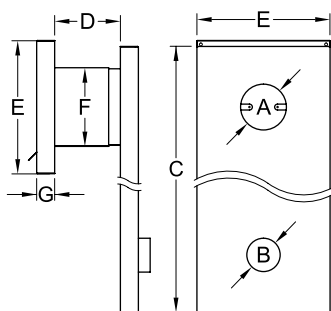

Functions similarly to the PWTOI, but designed for "up and out" installations (e.g. basement). The outside air channel is adjustable for height and can be painted any color to match the décor. Includes 10' of aluminum flex and 3' flex insulation.

Dimensions			INCHES
	3"	4"	
A	3 7/8	4 7/8	
B	2 7/8	2 7/8	
C	Adj. 44 - 68	Adj. 45 - 68	
D	min. 6 1/2 - max. 11 1/2		
E	11 1/4	12 1/4	
F	6 5/8	7 5/8	
G	1 1/2	1 1/2	

### Wall Thimble Extension (PWTE)

(PWTE)

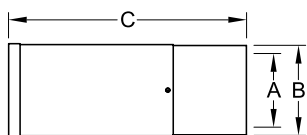

UL Listed Wall Thimble insulated extensions. They install easily and will allow wall thimbles to fit walls up to 20 3/4" thick.

Dimensions			INCHES
	3"	4"	
A	4 1/8	5 1/4	
B	6 1/4	7 1/4	
C	5 3/4 to 15		

### Ceiling Support/Radiation Shield (PSA)

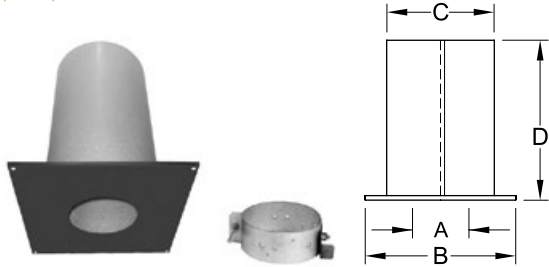

Rated to support up to 30' (3") or 25' (4") of venting where it passes through a floor or ceiling. It telescopes from 12" to 23" to keep insulation and debris away from the vent.

Dimensions		INCHES
	3"	4"
A	3 7/8	4 7/8
B	9 1/4	9 1/4
C	5 3/4	6 3/4
D	min. 12 - max. 23	

### Square Support/Radiation Shield (PSS)

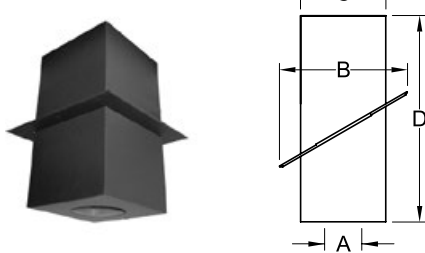

Rated to support up to 37' (3") or 30' (4") of venting where it passes through an insulated or un-insulated ceiling. It is particularly suitable for cathedral and drop ceilings.

Dimensions		INCHES
	3"	4"
A	3 7/8	4 7/8
B	10 3/4	10 3/4
C	6 5/8	6 5/8
D	16	16

### Adjustable Wall Support (PSW)

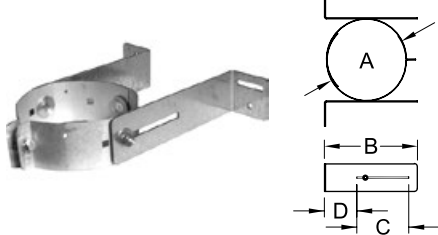

Rated to support up to 21' (3") or 17' (4") of venting. Fits 3" and 4" diameters. It adjusts easily to provide from 1" to 5" of clearance to the wall.

Dimensions		INCHES
	3"	4"
A	3 3/4	4 3/4
B	7 1/2	7 1/2
C	4 1/4	4 1/4
D	2 3/4	2 3/4

### Masonry Adapter (PAM)

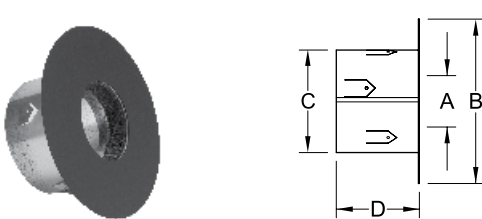

Provides a tight, positive transition to a masonry chimney. Fits existing masonry thimbles up to 8" in diameter.

Dimensions		INCHES
	3"	4"
A	3 15/16	4 15/16
B	9 1/2	9 1/2
C	5 7/8	5 7/8
D	3 3/4	3 3/4

### Type A Chimney Adapter (PAA5, PAA6, PAA7, PAA8)

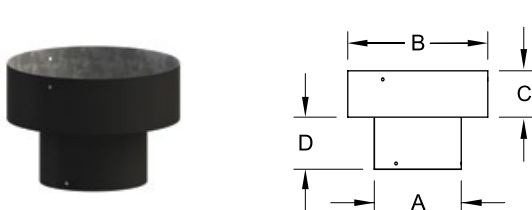

Provides a positive seal connection between EXCELPellet and class A chimneys. Connects 3" or 4" pellet vent to class A.

Dimensions		INCHES
	3"	4"
A	3 3/4	4 3/4
B	5, 6, 7 or 8	6, 7 or 8
C	2	2
D	2 1/4	2 1/4



### Type A Chimney Reline Adapter

(PAX6, PAX7, PAX8)

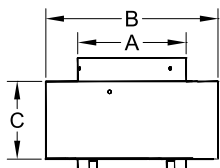
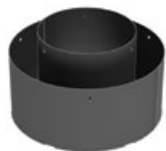

Permits re-lining of an existing pre-fab chimney with EXCELPellet or an approved flexible liner. Available to fit 6", 7" or 8" chimneys with 3" or 4" venting. Use the universal Chimney Adapter Cap (PCA) at the top.

		Dimensions	
		3"	4"
A		3 7/8	4 7/8
B		6, 7 or 8	
C		2 3/4	2 3/4

INCHES

### Chimney Adapter Cap

(PCA)

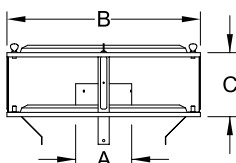

This cap will fit any brand of class A chimney up to an 8" I.D. It connects to EXCELPellet or a flexible liner used to re-line the existing chimney. Available in 3" or 4".

		Dimensions	
		3"	4"
A		3 3/4	4 3/4
B		13 1/2	13 1/2
C		5	5

INCHES

### Female Flex Adapter

(PAF, 3PAF4, PAF5, PAF55, PAF6)

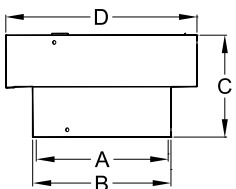

Connects ExcelPellet vent from an appliance to flexible liner coming from masonry flue.

Code	Dimensions			
	A	B	C	D
3PAF	3	3 3/4	5	3 5/8
3PAF4	3	3 3/4	2 3/4	4 5/8
3PAF5	3	3 3/4	3 1/2	5 1/2
3PAF55	3	3 3/4	3 1/2	6
3PAF6	3	3 3/4	3 1/2	6 1/2
4PAF	4	4 3/4	5	4 5/8
4PAF5	4	4 3/4	3 1/2	5 1/2
4PAF55	4	4 3/4	3 1/2	6
4PAF6	4	4 3/4	3 1/2	6 1/2

INCHES

### Flex Adapter Tee

(3PATF4, 4PATF4)

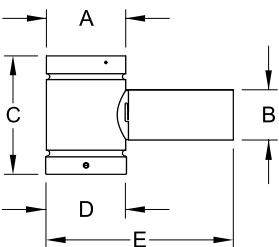

For pellet stove installations that are vented into a masonry chimney. The snout accepts EXCELPellet and connects EXCELPellet to a 4" flexible liner. The Flex Adapter tee has a removable twist mouth that is available in 3" or 4". Use in combination with the Masonry Adapter (PAM). Tee cap included.

		Dimensions	
		3"	4"
A		4 9/16	4 9/16
B		2 7/8	3 7/8
C		6 3/4	7 3/4
D		4 5/8	4 5/8
E		10 3/4	10 3/4

INCHES

### Pellet / Liner 5" Adapter (PAL5)

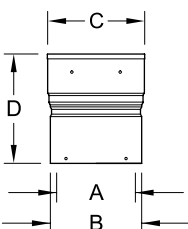

Provides a sealed connection where a rigid liner is installed above an EXCELPellet system.

		Dimensions	
		3"	4"
A		3	4
B		3 3/4	4 3/4
C		5	5
D		4 1/4	5 5/8

INCHES



### Universal Stove Adapter

(PAS, PASB)

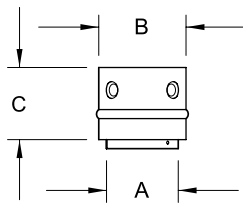

Universal adapter fits both large OD flue collars (e.g.: Harman) and small OD flue collars. The stove adapter fastens permanently to the stove but can be easily disconnected from the rest of the vent to simplify cleaning. Available in Galvalume or Black exterior.

Dimensions			INCHES
	3"	4"	
A	3	4	
B	3 5/8	4 5/8	
C	3 3/8		

### Tapered Stove Adapter (3PI4, 3PI4B)

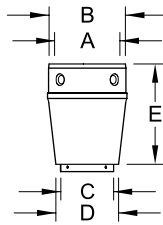

Universal Stove adapter that increases diameter from 3" to 4".

Dimensions		INCHES
A	4	
B	4 3/4	
C	3	
D	3 5/8	
E	6	

### Quick Disconnect Stove Adapter (PAQ)

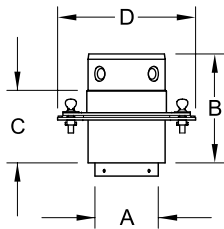

Makes cleaning and servicing pellet stoves dramatically easier. This stove adapter comes apart at the center by undoing two thumb screws. With the PAQ installed, there is no need to take lengths apart for cleaning.

Dimensions			INCHES
	3"	4"	
A	3	4	
B	5 3/8	5 3/8	
C	3 5/8	3 5/8	
D	4 3/4	5 3/4	

### Harman Stove Adapter

(PASH, PASH6)

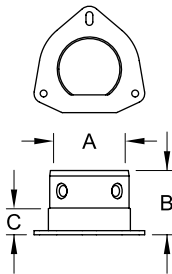

Bolts directly to Harman stoves and does not require silicone. Available in two lengths to accommodate stoves with extended hoppers. Includes a Harman Style Gasket (HG).

Dimensions			INCHES
	PASH	PASH6	
A	3	3	
B	2 7/8	6 3/8	
C	1 1/8	4 5/8	

### Harman Style Gaskets (HG)

(HG)

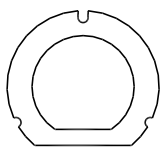

Replacement gaskets for the Harman Stove Adapter, comes in packs of 5.

### Adjustable Jet Cap

(PCJ)

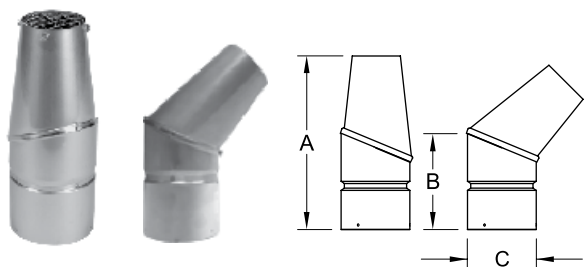

Can be rotated to direct hot flue gasses away from bushes or other things in proximity to the exhaust. Includes a spark screen.

INCHES		
Dimensions		
	3"	4"
A	9 3/8	9 3/4
B	5 1/2	5 7/8
C	3 3/4	4 3/4

### Horizontal Cap

(PCH)

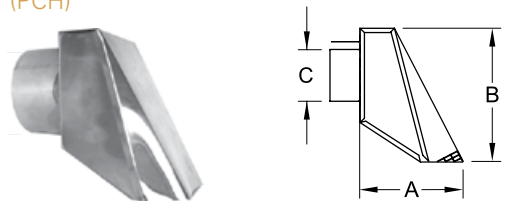

Directs and accelerates flue gasses away from the house reducing the possibility of "moustache effect" from smoke accumulation. Includes a spark screen.

INCHES		
Dimensions		
	3"	4"
A	5	6
B	6 1/4	8
C	3	4

### Spark Screen

(PCS)

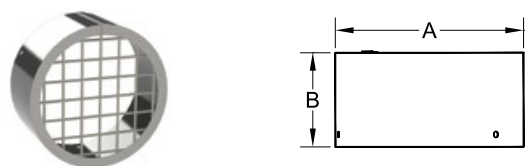

A stainless steel spark screen that fits any standard length or elbow to be used as a termination. Also fits Economy Cap (PCE).

INCHES		
Dimensions		
	3"	4"
A	3 3/4	4 3/4
B	1 7/8	1 7/8

### Vertical Rain Cap (PCR)

### Rain/Wind Shield (PRCW)

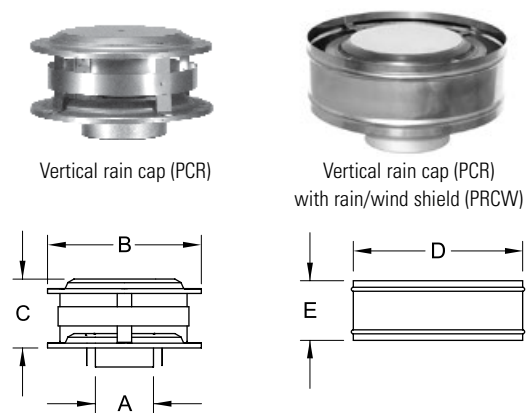

Constructed entirely of stainless steel and designed to provide good protection from wind and rain. An optional Wind/Rain Shield (PRCW) is available for added protection in harsh weather.

INCHES		
Dimensions		
	3"	4"
A	3	4
B	8	9
C	3 7/8	3 7/8
D	11	11
E	3 7/8	3 7/8

### Vertical Cap Spark Screen (PRCS)

(PRCS)



An optional stainless steel spark screen is available for installations where sparks can pose a safety problem

### Traditional Masonry Adapter Cap (PCT)

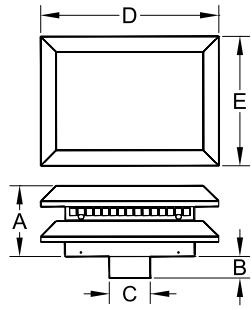

Certified for pellet appliances in a masonry chimney. Requires a flashing (CTF, or CTFC). The optional Wind / Rain Shield (CTS) can improve performance in extreme wind conditions. Cap can be reduced to 3 1/2" high to fit under slate or stone topped chimneys.

Dimensions		INCHES
A	6 1/2	
B	2 3/4	
C	3 3/4	
D	16 1/2	
E	12	

### Universal Flashing for Traditional Cap (CTF)

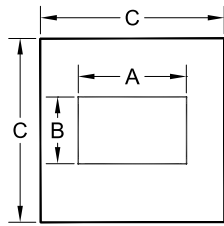

Made of galvalume, this flat flashing base is easy to cut, bend, or simply silicone to the top of a masonry chimney.

Dimensions		INCHES
A	11 3/4	
B	7 1/4	
C	20	

### Clay Tile Flashing for Traditional Cap (CTFC)

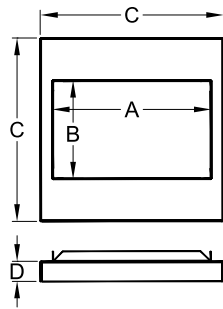

Made of galvalume and designed to fit onto a clay tile flue. Optional Hose Clamp Bracket (HC) can be used or it can be secured in the method of your choice.

Dimensions		INCHES
A	11 3/4	
B	7 1/4	
C	13 3/4	
D	1 1/2	

### Hose Clamp Bracket (HC)

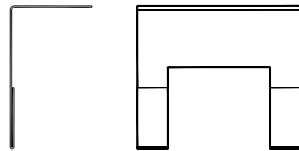
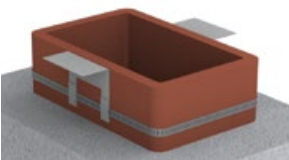

Heavy duty hose clamp and two mounting brackets for the Clay Tile Flashings (MFC and CTFC).

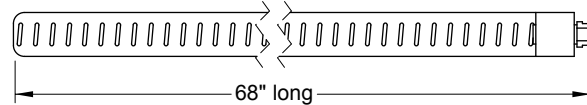

### Flashings (PF, PFA, PFB)

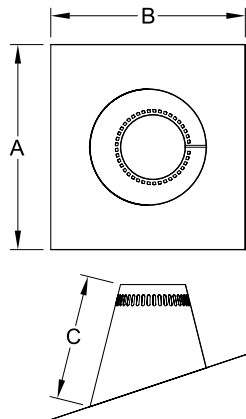

Flashing Dimensions						INCHES
Pitch	Code	Flue I.D.	A x B	C	Storm Collar	
Flat - 2/12	3PF	3	15 7/8 x 15 7/8	8 1/16	ØPSC	
	4PF	4	15 7/8 x 15 7/8	8 1/16	ØPSC	
1/12 - 7/12	3PFA	3	18 x 15 15/16	9 3/4	ØPSC	
	4PFA	4	18 x 15 15/16	10	ØPSC	
8/12-12/12	3PFB	3	22 1/2 x 18	14 1/4	ØPSC	
	4PFB	4	24 x 18	15 5/16	ØPSC	

A storm collar is included with purchase of a flashing

## Storm Collars

(PSC)

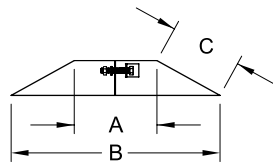

Dimensions		
	<b>3"</b>	<b>4"</b>
A	3 3/4	4 3/4
B	9 7/16	10 7/16
C	4	4

INCHES

## Metal Roof Flashing Adapter

(MFA, MFB)

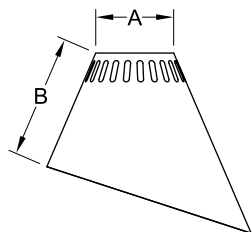

This flashing cone fits onto a 6" EXCEL Metal Roof Flashing (6EMFA or 6EMFB, page 16) to convert it for use with EXCELPellet vent or EXCELDirect. **Metal Roof Flashing and storm collar ordered separately.**

Dimensions				
<b>Code</b>	<b>3MFA</b>	<b>3MFB</b>	<b>4MFA</b>	<b>4MFB</b>
A	4	4	5	5
B	9 1/2	11 1/8	8	9 1/2

INCHES

# EXCELPellet Offset Tables

Use this table if you are not installing an adjustable length between the elbows

LENGTH BETWEEN OFFSETS	45° Elbows	
	RISE	OFFSET
<b>3 INCH Ø</b>		
NO LENGTH	7	2 3/4
6" Length	9 3/4	5 3/4
12" Length	14	10
24" Length	23 1/4	19 1/4
36" Length	31	27
48" Length	39 1/2	35 1/2
48" + 6" Length	42 1/2	38 1/2
48" + 12" Length	46 3/4	42 3/4
48" + 24" Length	55 3/4	51 3/4
48" + 36" Length	63 3/4	59 1/2
48" + 48" Length	72	68
48" + 48" + 12" Length	79 1/4	75 1/4
48" + 48" + 24" Length	88 1/2	84 1/2
<b>4 INCH Ø</b>		
NO LENGTH	7 1/4	3
6" Length	10	6
12" Length	14 1/4	10 1/4
24" Length	23 1/2	19 1/4
36" Length	31 1/4	27
48" Length	39 3/4	35 1/2
48" + 6" Length	42 3/4	38 1/2
48" + 12" Length	47	42 3/4
48" + 24" Length	56 1/4	52
48" + 36" Length	64	59 3/4
48" + 48" Length	72 1/2	68 1/4
48" + 48" + 12" Length	79 1/2	75 1/4
48" + 48" + 24" Length	88 3/4	84 1/2

All measurements are in inches

Use this table if you are installing a 16" adjustable length between the elbow

LENGTH BETWEEN OFFSETS	45° Elbows	
	RISE	OFFSET
<b>3 INCH Ø</b>		
6" Length*	13 1/2 - 21 1/2	9 1/2 - 17 1/2
12" Length	15 1/2 - 23 1/2	11 1/2 - 19 1/2
12" + 6" Length*	18 1/2 - 26 1/4	14 1/4 - 22 1/4
24" Length	24 3/4 - 32 1/2	20 1/2 - 28 1/2
36" Length	32 1/2 - 40 1/2	28 1/2 - 36 1/4
48" Length	41 - 48 3/4	37 - 44 3/4
48" + 6" Length	43 3/4 - 51 3/4	39 3/4 - 47 3/4
48" + 12" Length	48 - 56	44 - 52
48" + 24" Length	57 1/4 - 65 1/4	53 1/4 - 61 1/4
48" + 36" Length	65 - 73	61 - 69
48" + 48" Length	41 - 48 3/4	69 1/2 - 77 1/2
48" + 48" + 12" Length	80 3/4 - 88 3/4	76 3/4 - 84 1/2
48" + 48" + 24" Length	90 - 97 3/4	85 3/4 - 93 3/4
<b>4 INCH Ø</b>		
6" Length*	13 3/4 - 21 3/4	9 1/2 - 17 1/2
12" Length	15 3/4 - 23 3/4	11 1/2 - 19 1/2
12" + 6" Length*	18 3/4 - 26 3/4	14 1/2 - 22 1/2
24" Length	25 - 33	20 3/4 - 28 3/4
36" Length	32 3/4 - 40 3/4	28 1/2 - 36 1/2
48" Length	41 1/4 - 49 1/4	37 - 45
48" + 6" Length	44 1/4 - 52	40 - 48
48" + 12" Length	48 1/2 - 56 1/4	44 1/4 - 52
48" + 24" Length	57 1/2 - 65 1/2	53 1/4 - 61 1/4
48" + 36" Length	65 1/4 - 73 1/4	61 1/4 - 69
48" + 48" Length	73 3/4 - 81 3/4	69 1/2 - 77 1/2
48" + 48" + 12" Length	81 - 89	76 3/4 - 84 3/4
48" + 48" + 24" Length	90 1/4 - 98 1/4	86 - 94

All measurements are in inches

\* Use a 6" adjustable length instead of the 16" adjustable length