

ULTRABlack

DOUBLE WALL STOVE PIPE



ULTRABlack Technical Information

Certification

ULTRABlack has been tested and listed by Intertek Testing Services.

Applications

ULTRABlack is designed to be used as a connector between a freestanding oil, wood or coal burning stove and a masonry or metal chimney. There are four primary advantages to ULTRABlack over single wall connector pipes:

- It offers reduced clearance to combustible materials.
- It is designed to last the lifetime of the stove and/or chimney system.
- It offers reduced creosote formation.
- It is certified for use with mobile home stoves.

Allowable Flue Gas Temperatures

Max Continuous	650°C (1200°F)
Brief Forced Firing	925°C (1700°F)
Tested To	1150°C (2100°F)

Clearance to Combustible Materials

ULTRABlack is certified for 6" clearance with the following exception. When ULTRABlack is used as the connector on a mobile home certified stove the clearance is determined by the installation instructions for the specific stove model being installed.

Construction

Flue: .016" stainless steel.

Casing: .019" satin coat steel. Satin coat is specifically designed to be painted.

Seam: Interior and exterior seams are seam welded.

Wall thickness: Approximately 3/8"

Paint: Forrest "Stove Bright" flat black

ULTRABlack Engineering and Design Considerations

Maximum allowable overall height:

There is no maximum requirement however, as a general guideline we recommend that the length of ULTRABlack not exceed 20 feet.

ULTRABlack assembles like a regular single wall stove pipe - no complicated, unsightly twist lock connectors or spot welds. There is no cutting required and all the screw holes are predrilled. Just put one piece on top of the other and screw together using the black oxide screws provided. Easily fits most stoves, including cast iron stoves and stoves with oval collars. ULTRABlack is approved for mobile home installation on most major stove brands, when installed with EXCEL insulated chimney. For mobile home installations follow the stove manufacturer's installation instructions.

EXCEL ULTRABlack

Fully Shielded Stove pipe with smooth, clean lines.

- Requires just 6" clearance to combustibles in all diameters - even when installed in a corner, or parallel with a ceiling*.
- Has a smooth, clean appearance to compliment any stove installation.
- Maximizes flue gas temperature, ensuring good draft.
- Minimizes creosote buildup.

* Some stoves may require greater clearances.



ULTRABlack Product Descriptions

Lengths (UB5F, UB1F, UB18F, UB2F & UB3F)

Lengths are available in 5", 12", 18", 24" and 36".

Adjustable Lengths (UBAF)

Adjustable Lengths combine a 36" length and a 36" slip length in one box. The UBAF fits all brands of insulated chimney and most brands of wood burning stoves without a stove or chimney adapter. A UBTC trim collar is included with the UBAF.

Slip Lengths (UB6SF, UB1SF & UB18SF)

Slip Lengths slide over a regular straight length allowing you to adjust the overall length of a straight run without cutting. The minimum adjustment can be reached only if the length used below the slip length is long enough to accept it.

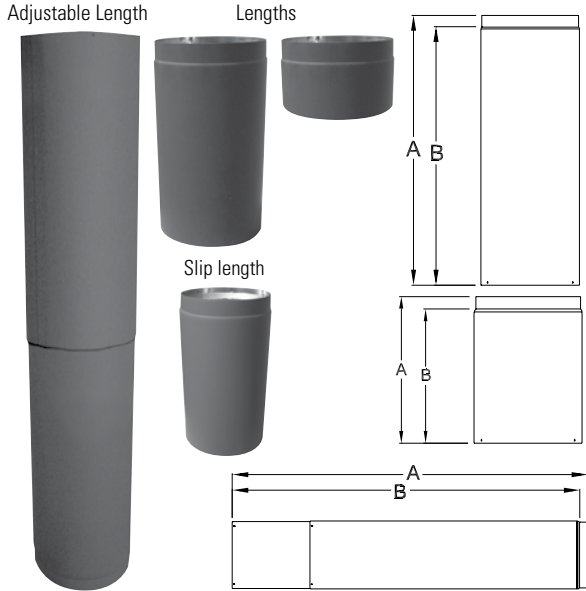

INCHES

Length Dimensions (6-7-8")		
Code	A	B
6-7-8 UB5F	5	4
6-7-8 UB1F	12	11
6-7-8 UB18F	18	17
6-7-8 UB2F	24	23
6-7-8 UB3F	36	35

INCHES

Slip Length Dimensions				
Code	A MIN.	A MAX.	B MIN.	B MAX.
UB6SF	2	6	1	5
UB1SF	2	12	1	11
UB18SF	2	18	1	17

INCHES

Adjustable Length Dimensions				
Code	A MIN.	A MAX.	B MIN.	B MAX.
6UBAF	40	68	39	67
7UBAF	40	68	39	67
8UBAF	40	68	39	67

Tees (UBT)

Combines a 90° transition with a clean out. Includes a tee cap.

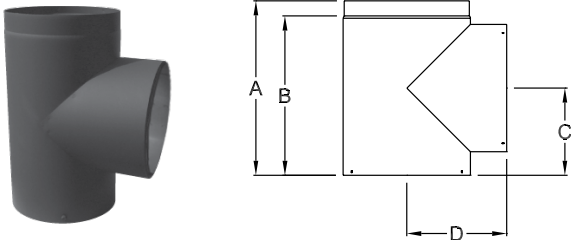

INCHES

Dimensions				
Code	A	B	C	D
6UBT	12	11	6	5 7/8
7UBT	12	11	6	6 3/8
8UBT	12	11	6	6 7/8

Elbows (UB30, UB45 & UB90)

(UB30, UB45 & UB90)

Are available in 30°, 45° and 90°.

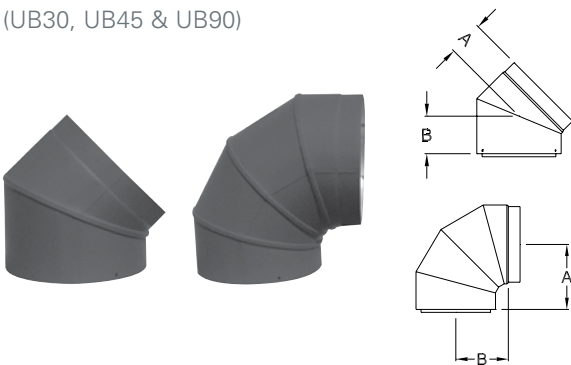

INCHES

Dimensions (30°, 45°, 90°)		
Code	A	B
6UB30	2 5/16	2 9/16
7UB30	2 7/16	2 11/16
8UB30	2 9/16	2 13/16
6UB45	2 3/4	3
7UB45	2 15/16	3 3/16
8UB45	3 1/8	3 3/8
6UB90	5 9/16	4 1/2
7UB90	6 1/16	5
8UB90	6 9/16	5 1/2

Reducers

(UBR)

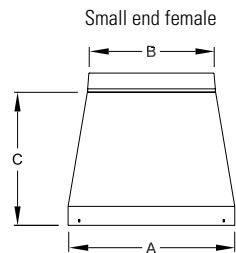

Designed to reduce the diameter of a system to accommodate a range of flue sizes, appliances and installations. *Note: Decreasing chimney diameter even 1" can have a serious negative impact of chimney performance. Be careful to use these components only when appropriate.*

INCHES

Dimensions			
Code	A	B	C
UBR76	7	6	7
UBR86	8	6	7
UBR87	8	7	7

Increasesers

(UBI)

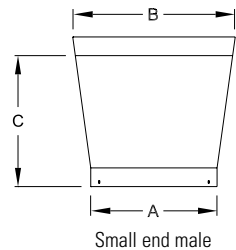

Designed to increase the diameter of a system to accommodate a range of flue sizes, appliances and installations. *Note: Increasing chimney diameter can reduce draft and increase creosote formation. Be careful to use these components only when appropriate.*

INCHES

Dimensions			
Code	A	B	C
UBI56	5	6	7
UBI67	6	7	7
UBI68	6	8	7
UBI78	7	8	7

Oval to Round Adapter

(UBORF)

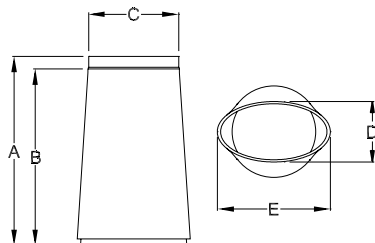

Adapters are designed to connect ULTRABlack to stoves with oval flue collars - such as a Vermont Castings Defiant Encore. Available in 8" only.

INCHES

Dimensions (8" only)					
Code	A	B	C	D	E
8UBORF	18	17	8	5 3/4	10 3/4

Stove Adapters

(UBSE)

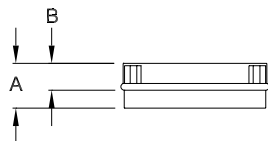

Primarily used with cast iron flue collars. Connect ULTRABlack to stoves with flue collars that do not project above the top of the stove. It can also be used to connect to stoves with irregular shaped or sized flue collars.

INCHES

Dimensions		
Code	A	B
6UBSE	2 1/2	1 1/2
7UBSE	2 1/2	1 1/2
8UBSE	2 1/2	1 1/2

Barometric Damper Adapter

(SWBA)

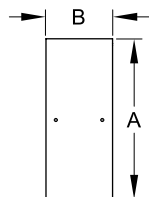

This adapter simplifies the connection between a barometric damper and an EXCELPrime or ULTRABlack tee.

INCHES

Dimensions		
Code	A	B
6SWBA	6 1/16	2 3/8
7SWBA	7 1/16	2 3/8
8SWBA	8 1/16	2 3/8

Masonry Adapter

(UBM)

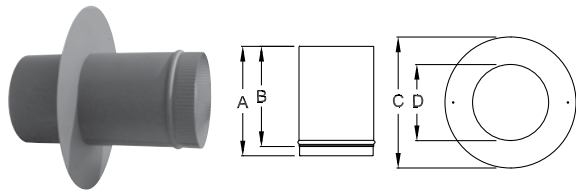

This part acts as a thimble sleeve to secure ULTRABlack to a masonry chimney that does not have a thimble or has an oversize one. *Note: ULTRABlack is not certified to pass through a combustible wall. An EXCEliner Insulated Thimble (ITH) must be used where there is a combustible wall between the stove and the masonry chimney. Flat trim collar included.*

INCHES

Dimensions				
Code	A	B	C	D
6UBM	11 7/8	10 7/8	12	6 1/8
7UBM	11 7/8	10 7/8	13	7 1/8
8UBM	11 7/8	10 7/8	14	8 1/8

Masonry Thimble Adapter

(UBMA)

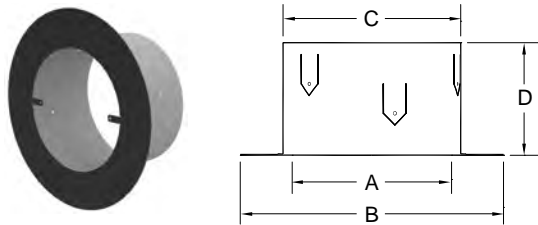

Connect ULTRABlack to a masonry chimney with an existing 8" thimble. *Note: ULTRABlack is not certified to pass through a combustible wall. An EXCEliner Insulated Thimble (ITH) must be used where there is a combustible wall between the stove and the masonry chimney.*

INCHES

Dimensions				
Code	A	B	C	D
6UBMA	6 7/8	11 1/8	7 1/2	4 3/4

Damper Section

(UBD)

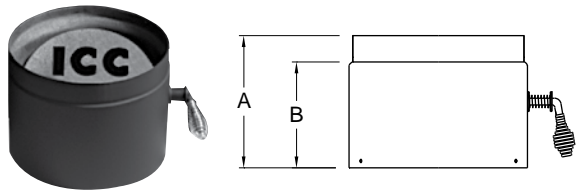

Butterfly type in line dampers. They are recommended by some stove manufacturers to help control draft.

INCHES

Dimensions		
Code	A	B
UBD	5	4

Trim Collars

(UBTC)



Covers the crimped (top) end of ULTRABlack where it connects to the insulated chimney. A UBTC is included with every UBAF so they rarely need to be purchased separately.

INCHES

Dimensions	
Code	Dimensions
6UBTC	22 x 2
7UBTC	25 3/8 x 2
8UBTC	28 1/2 x 2

Conical Trim Ring

(UBTR)

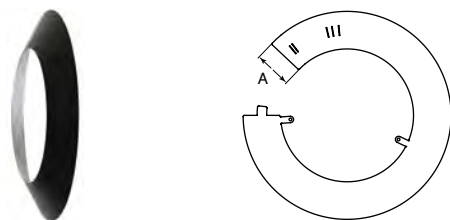

Adjustable to fit the exterior of regular ULTRABlack lengths and slip lengths. There are also slots to fit fixed and slip EXCELDirect lengths as well as single wall black pipe. Available in 6" or 8".

INCHES

Dimensions	
Code	A
UBTR	3"

ULTRABlack Offset Tables

45° ELBOWS UB OFFSET TABLE - Use this table if you are not installing a slip length (UBSF) between the elbows.

LENGTH BETWEEN ELBOWS	45° Elbows	
	RISE	OFFSET
6 INCH Ø		
NO LENGTH	8 1/4	3 1/2
5" Length	11	6 1/4
12" Length	16	11 1/4
18" Length	20 1/4	15 1/2
24" Length	24 1/2	19 3/4
36" Length	33	28 1/4
7 INCH Ø		
NO LENGTH	9	3 3/4
5" Length	11 3/4	6 1/2
12" Length	16 3/4	11 1/2
18" Length	21	15 3/4
24" Length	25 1/4	20
36" Length	33 3/4	28 1/2
8 INCH Ø		
NO LENGTH	9 3/4	4
5" Length	12 1/2	7
12" Length	17 1/2	11 3/4
18" Length	21 3/4	16
24" Length	26	20 1/4
36" Length	34 1/2	28 3/4

All measurements are in inches

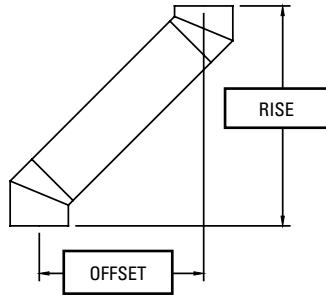

45° ELBOWS UB OFFSET TABLE - Use this table if you are installing an adjustable length between the elbows.

LENGTH BETWEEN 45 ELBOWS	45° Elbows	
	RISE	OFFSET
6 INCH Ø		
NO LENGTH + UB6SF	9 1/4 - 11	4 1/2 - 6 1/4
5" LENGTH + UB6SF	12 - 14	7 1/4 - 9 1/4
5" LENGTH + UB12SF	16 - 18 1/4	11 1/4 - 13 1/2
12" LENGTH + UB12SF	17 - 23	12 1/4 - 18 1/4
18" LENGTH + UB12SF	21 1/4 - 27 1/4	16 1/2 - 22 1/2
24" LENGTH + UB18SF	25 1/2 - 35 3/4	20 3/4 - 31
UBAF	36 1/2 - 56 1/4	31 3/4 - 51 1/2
18" LENGTH + UBAF	47 3/4 - 67 3/4	43 - 63
36"+36"+12" + UB18SF	66 1/2 - 76 3/4	61 3/4 - 72
36"+36"+24" + UB18SF	75 - 85 1/4	70 1/4 - 80 1/2
36"+36"+36" + UB18SF	83 1/2 - 93 3/4	78 3/4 - 89
7 INCH Ø		
NO LENGTH + UB6SF	10 - 11 3/4	4 3/4 - 6 1/2
5" LENGTH + UB6SF	12 3/4 - 14 3/4	7 1/2 - 9 1/2
5" LENGTH + UB12SF	16 3/4 - 19	7 1/2 - 13 3/4
12" LENGTH + UB12SF	17 3/4 - 23 3/4	12 1/2 - 18 1/2
18" LENGTH + UB12SF	22 - 28	16 3/4 - 22 3/4
24" LENGTH + 18UBSF	26 1/4 - 36 1/2	21 - 31 1/4
UBAF	37 1/4 - 57	32 - 51 3/4
18" LENGTH + UBAF	48 1/2 - 68 1/2	43 1/4 - 63 1/4
36"+36"+12" + UB18SF	67 1/4 - 77 1/2	62 - 72 1/4
36"+36"+12" + UB18SF	75 3/4 - 86	70 1/2 - 80 3/4
36"+36"+12" + UB18SF	84 1/4 - 94 1/2	79 - 89 1/4
8 INCH Ø		
NO LENGTH + UB6SF	10 1/2 - 12 1/2	5 - 7
5" LENGTH + UB6SF	13 1/2 - 15 1/4	7 3/4 - 9 3/4
5" LENGTH + UB12SF	17 1/2 - 19 1/2	7 3/4 - 14
12" LENGTH + UB12SF	18 1/4 - 24 1/2	12 3/4 - 19
18" LENGTH + UB12SF	22 1/2 - 28 3/4	17 - 23 1/4
24" LENGTH + 18UBSF	26 3/4 - 37 1/4	21 1/4 - 31 3/4
UBAF	38 - 57 3/4	32 1/4 - 52 1/4
18" LENGTH + UBAF	49 1/4 - 69	43 3/4 - 63 1/2
36"+36"+12" + UB18SF	67 3/4 - 78 1/4	62 1/4 - 72 3/4
36"+36"+12" + UB18SF	76 1/4 - 86 3/4	70 3/4 - 81 1/4
36"+36"+12" + UB18SF	84 3/4 - 95 1/4	79 1/4 - 89 1/2

All measurements are in inches

30° ELBOWS

UB OFFSET TABLE- Use this table when a slip length (UBSF) is not installed between the elbows.

LENGTH BETWEEN OFFSETS	30° Elbows	
	RISE	OFFSET
6 INCH Ø		
NO LENGTH	7 1/4	2
5" Length	10 1/2	4
12" Length	16 3/4	7 1/2
18" Length	21 3/4	10 1/2
24" Length	27	13 1/2
36" Length	37 1/2	19 1/2
7 INCH Ø		
NO LENGTH	7 3/4	2
5" Length	11	4
12" Length	17 1/4	7 1/2
18" Length	22 1/4	10 1/2
24" Length	27 1/2	13 1/2
36" Length	38	19 1/2
8 INCH Ø		
NO LENGTH	8 1/4	2 1/4
5" Length	11 3/4	4 1/4
12" Length	17 3/4	7 3/4
18" Length	23	10 3/4
24" Length	28 1/4	13 3/4
36" Length	38 1/2	19 3/4

All measurements are in inches

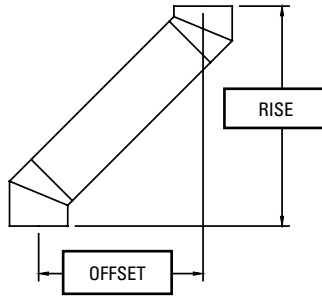

30° ELBOWS

UB OFFSET TABLE- Use this table if you are installing an adjustable length between the elbows.

LENGTH BETWEEN ELBOWS	30° Elbows	
	RISE	OFFSET
6 INCH Ø		
NO LENGTH + UB6SF	8 1/4 - 10 1/2	2 3/4 - 4
5" LENGTH + UB6SF	11 3/4 - 14	4 3/4 - 6
5" LENGTH + UB12SF	16 3/4 - 19 1/4	7 1/2 - 9
12" LENGTH + UB12SF	17 3/4 - 25 1/4	8 1/4 - 12 1/2
18" LENGTH + UB12SF	23 - 30 1/2	11 1/4 - 15 1/2
24" LENGTH + UB18SF	28 1/4 - 41	14 1/4 - 21 1/2
UBAF	41 3/4 - 66	22 - 36
18" LENGTH + UBAF	55 1/2 - 79 3/4	30 - 44
36"+36"+12" + UB18SF	78 1/4 - 91 1/4	43 1/4 - 50 1/2
36"+36"+24" + UB18SF	88 3/4 - 101 1/2	49 1/4 - 56 1/2
36"+36"+36" + UB18SF	99 1/4 - 112	55 1/4 - 62 1/2
7" INCH Ø		
NO LENGTH + UB6SF	8 3/4 - 11	2 3/4 - 4
5" LENGTH + UB6SF	12 1/4 - 14 1/2	4 3/4 - 6
5" LENGTH + UB12SF	17 1/4 - 19 3/4	7 1/2 - 9
12" LENGTH + UB12SF	18 1/4 - 25 3/4	8 1/4 - 12 1/2
18" LENGTH + UB12SF	23 1/2 - 31	11 1/4 - 15 1/2
24" LENGTH + 18UBSF	28 3/4 - 41 1/2	14 1/4 - 21 1/2
UBAF	42 1/4 - 66 1/2	22 - 36
18" LENGTH + UBAF	56 - 80 1/4	30 - 44
36"+36"+12" + UB18SF	78 3/4 - 91 3/4	43 1/4 - 50 1/2
36"+36"+12" + UB18SF	89 1/4 - 102	49 1/4 - 56 1/2
36"+36"+12" + UB18SF	99 3/4 - 112 1/2	55 1/4 - 62 1/2
8" INCH Ø		
NO LENGTH + UB6SF	9 1/4 - 11 3/4	3 - 4 1/4
5" LENGTH + UB6SF	12 3/4 - 15 1/4	5 - 6 1/4
5" LENGTH + UB12SF	17 3/4 - 20 1/4	7 3/4 - 9 1/4
12" LENGTH + UB12SF	18 3/4 - 26 1/2	8 1/2 - 12 3/4
18" LENGTH + UB12SF	24 - 31 3/4	11 1/2 - 15 3/4
24" LENGTH + 18UBSF	29 1/4 - 42	14 1/2 - 21 3/4
UBAF	43 - 67 1/4	22 1/4 - 36 1/4
18" LENGTH + UBAF	56 3/4 - 81	30 1/4 - 44 1/4
36"+36"+12" + UB18SF	79 1/2 - 92 1/4	43 1/2 - 50 3/4
36"+36"+12" + UB18SF	89 3/4 - 102 3/4	49 1/2 - 56 3/4
36"+36"+12" + UB18SF	100 1/4 - 113	55 1/2 - 62 3/4

All measurements are in inches