

# ULTRABlack

DOUBLE WALL STOVE PIPE



# ULTRABlack Technical Information

## Certification

ULTRABlack has been tested and listed by Intertek Testing Services to ULC S641 standards.

## Applications

ULTRABlack is designed to be used as a connector between a freestanding oil, wood or coal burning stove and a masonry or metal chimney. There are four primary advantages to ULTRABlack over single wall connector pipes:

- It offers reduced clearance to combustible materials.
- It is designed to last the lifetime of the stove and/or chimney system.
- It offers reduced creosote formation.
- It is certified for use with mobile home stoves.

## Allowable Flue Gas Temperatures

Max Continuous	650°C (1200°F)
Brief Forced Firing	925°C (1700°F)
Tested To	1150°C (2100°F)

## Clearance to Combustible Materials

ULTRABlack is certified for 6" clearance with the following exception. When ULTRABlack is used as the connector on a mobile home certified stove the clearance is determined by the installation instructions for the specific stove model being installed.

## Construction

**Flue:** .016" stainless steel.

**Casing:** .019" satin coat steel. Satin coat is specifically designed to be painted.

**Seam:** Interior and exterior seams are seam welded.

**Wall thickness:** Approximately 3/8"

**Paint:** Forrest "Stove Bright" flat black

# ULTRABlack Engineering and Design Considerations

## Maximum allowable overall height:

There is no maximum requirement however, as a general guideline we recommend that the length of ULTRABlack not exceed 20 feet.

ULTRABlack assembles like a regular single wall stove pipe - no complicated, unsightly twist lock connectors or spot welds. There is no cutting required and all the screw holes are predrilled. Just put one piece on top of the other and screw together using the black oxide screws provided. Easily fits most stoves, including cast iron stoves and stoves with oval collars. ULTRABlack is approved for mobile home installation on most major stove brands, when installed with EXCEL insulated chimney. For mobile home installations follow the stove manufacturer's installation instructions.

## EXCEL ULTRABlack

Fully Shielded Stove pipe with smooth, clean lines.

- Requires just 6" clearance to combustibles in all diameters - even when installed in a corner, or parallel with a ceiling\*.
- Has a smooth, clean appearance to compliment any stove installation.
- Maximizes flue gas temperature, ensuring good draft.
- Minimizes creosote buildup.

\* Some stoves may require greater clearances.



# ULTRABlack Product Descriptions

## Lengths (UB5F, UB1F, UB18F, UB2F & UB3F)

Lengths are available in 5", 12", 18", 24" and 36".

## Adjustable Lengths (UBAF)

Adjustable Lengths combine a 36" length and a 36" slip length in one box. The UBAF fits all brands of insulated chimney and most brands of wood burning stoves without a stove or chimney adapter. A UBTC trim collar is included with the UBAF.

## Slip Lengths (UB6SF, UB1SF & UB18SF)

Slip Lengths slide over a regular straight length allowing you to adjust the overall length of a straight run without cutting. The minimum adjustment can be reached only if the length used below the slip length is long enough to accept it.

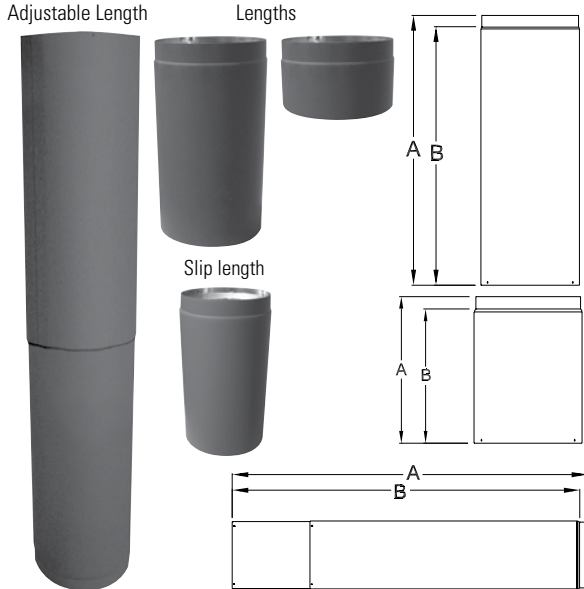

INCHES

Length Dimensions (6-7-8")		
Code	A	B
6-7-8 UB5F	5	4
6-7-8 UB1F	12	11
6-7-8 UB18F	18	17
6-7-8 UB2F	24	23
6-7-8 UB3F	36	35

INCHES

Slip Length Dimensions				
Code	A MIN.	A MAX.	B MIN.	B MAX.
UB6SF	2	6	1	5
UB1SF	2	12	1	11
UB18SF	2	18	1	17

INCHES

Adjustable Length Dimensions				
Code	A MIN.	A MAX.	B MIN.	B MAX.
6UBAF	40	68	39	67
7UBAF	40	68	39	67
8UBAF	40	68	39	67

## Tees (UBT)

Combines a 90° transition with a clean out. Includes a tee cap (SE-ØSWTP).

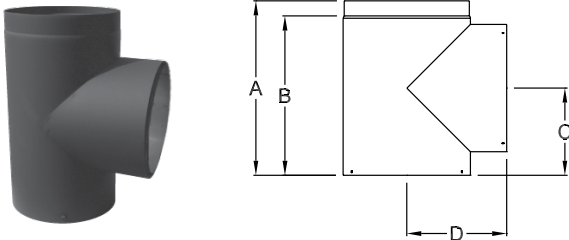

INCHES

Dimensions				
Code	A	B	C	D
6UBT	12	11	6	5 7/8
7UBT	12	11	6	6 3/8
8UBT	12	11	6	6 7/8

## Elbows

(UB30, UB45 & UB90)

Are available in 30°, 45° and 90° (15° in 6" only).

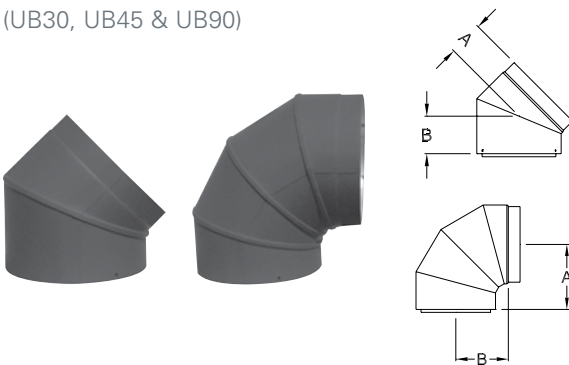

INCHES

Dimensions (30°, 45°, 90°)		
Code	A	B
6UB15	1 3/4	2
6UB30	2 5/16	2 9/16
7UB30	2 7/16	2 11/16
8UB30	2 9/16	2 13/16
6UB45	2 3/4	3
7UB45	2 15/16	3 3/16
8UB45	3 1/8	3 3/8
6UB90	5 9/16	4 1/2
7UB90	6 1/16	5
8UB90	6 9/16	5 1/2

### Reducers

(UBR)

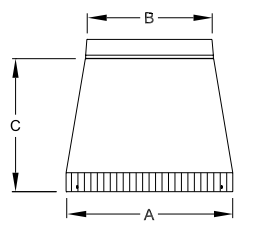

Large end crimped/male end

Designed to reduce the diameter of a system to accommodate a range of flue sizes, appliances and installations. *Note: Decreasing chimney diameter even 1" can have a serious negative impact of chimney performance. Be careful to use these components only when appropriate.*

INCHES

Dimensions			
Code	A	B	C
UBR76	7	6	7
UBR86	8	6	7
UBR87	8	7	7

### Increasesers

(UBI)

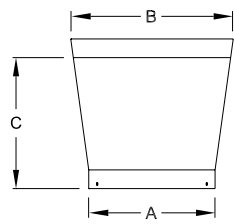

Small end male

Designed to increase the diameter of a system to accommodate a range of flue sizes, appliances and installations. *Note: Increasing chimney diameter can reduce draft and increase creosote formation. Be careful to use these components only when appropriate.*

INCHES

Dimensions			
Code	A	B	C
UBI56	5	6	7
UBI67	6	7	7
UBI68	6	8	7
UBI78	7	8	7

### Oval to Round Adapter

(UBORF)

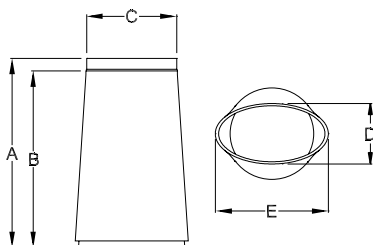

Adapters are designed to connect ULTRABlack to stoves with oval flue collars - such as a Vermont Castings Defiant Encore. Available in 8" oval to 8" round only.

INCHES

Dimensions (8" only)					
Code	A	B	C	D	E
8UBORF	18	17	8	5 3/4	10 3/4

### Stove Adapters

(UBSE)

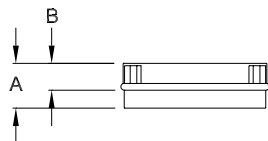

Primarily used with cast iron flue collars. Connect ULTRABlack to stoves with flue collars that do not project above the top of the stove. It can also be used to connect to stoves with irregular shaped or sized flue collars.

INCHES

Dimensions		
Code	A	B
6UBSE	2 1/2	1 1/2
7UBSE	2 1/2	1 1/2
8UBSE	2 1/2	1 1/2

### Barometric Damper Adapter

(SWBA)

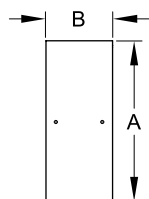

This adapter simplifies the connection between a barometric damper and an EXCELPrime or ULTRABlack tee.

INCHES

Dimensions		
Code	A	B
6SWBA	6 1/16	2 3/8
7SWBA	7 1/16	2 3/8
8SWBA	8 1/16	2 3/8

### Masonry Adapter

(UBM)

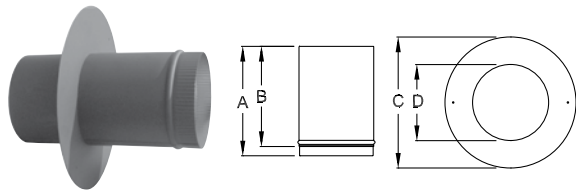

This part acts as a thimble sleeve to secure ULTRABlack or Prime to a masonry chimney that does not have a thimble or has an oversize one. *Note: ULTRABlack is not certified to pass through a combustible wall. An EXCELiner Insulated Thimble (ITH) must be used where there is a combustible wall between the stove and the masonry chimney. Flat trim collar included.*

INCHES

Dimensions				
Code	A	B	C	D
6UBM	11 7/8	10 7/8	12	6 1/8
7UBM	11 7/8	10 7/8	13	7 1/8
8UBM	11 7/8	10 7/8	14	8 1/8

### Masonry Thimble Adapter

(UBMA)

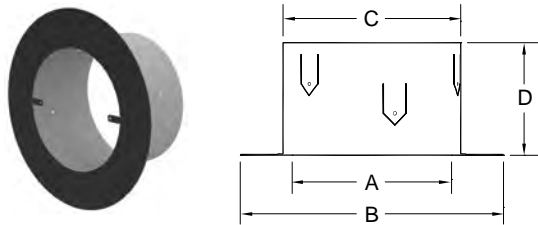

Connect ULTRABlack to a masonry chimney with an existing 8" thimble. *Note: ULTRABlack is not certified to pass through a combustible wall. An EXCELiner Insulated Thimble (ITH) must be used where there is a combustible wall between the stove and the masonry chimney.*

INCHES

Dimensions				
Code	A	B	C	D
6UBMA	6 7/8	11 1/8	7 1/2	4 3/4

### Damper Section

(UBD)

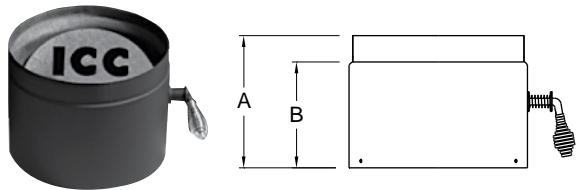

Butterfly type in line damper. They are recommended by some stove manufacturers to help control draft.

INCHES

Dimensions		
Code	A	B
UBD	5	4

### Trim Collars

(UBTC)



Covers the crimped (top) end of ULTRABlack where it connects to the insulated chimney. A UBTC is included with every UBAF so they rarely need to be purchased separately.

INCHES

Dimensions	
Code	Dimensions
6UBTC	22 x 2
7UBTC	25 3/8 x 2
8UBTC	28 1/2 x 2

### Conical Trim Ring

(UBTR)

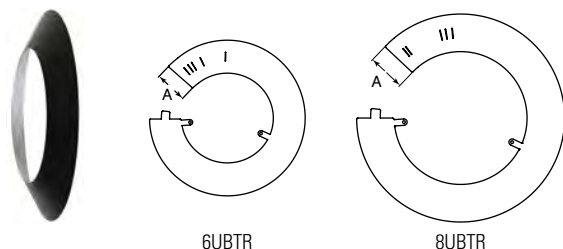

Adjustable to fit the exterior of regular ULTRABlack lengths and slip lengths. There are also slots to fit EXCELPPrime single wall pipe. Available in 6" or 8".

INCHES

Dimensions	
Code	A
UBTR	3"

# ULTRABlack Offset Tables

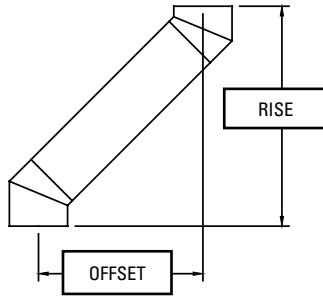

Use this table if you are not installing an adjustable length between the elbows.

LENGTH BETWEEN OFFSETS	15° Elbows		30° Elbows		45° Elbows	
	RISE	OFFSET	RISE	OFFSET	RISE	OFFSET
<b>6 INCH Ø</b>						
NO LENGTH	3 3/4	1/2	7 1/4	2	8 1/4	3 1/2
5" Length	7 1/2	1 1/2	10 1/2	4	11	6 1/4
6" Slip Length	7 1/2	1 1/2	-	-	-	-
12" Length	14 1/4	3 1/4	16 3/4	7 1/2	16	11 1/4
18" Length	20	4 3/4	21 3/4	10 1/2	20 1/4	15 1/2
24" Length	26	6 1/2	27	13 1/2	24 1/2	19 3/4
36" Length	37 1/2	9 1/2	37 1/2	19 1/2	33	28 1/4
UBAF min	42 1/4	10 3/4	-	-	-	-
UBAF max	69 1/4	18	-	-	-	-
<b>7 INCH Ø</b>						
NO LENGTH	3 3/4	1/2	7 3/4	2	9	3 3/4
5" Length	7 1/2	1 1/2	11	4	11 3/4	6 1/2
6" Slip Length	7 1/2	1 1/2	-	-	-	-
12" Length	14 1/4	3 1/4	17 1/4	7 1/2	16 3/4	11 1/2
18" Length	20	4 3/4	22 1/4	10 1/2	21	15 3/4
24" Length	26	6 1/2	27 1/2	13 1/2	25 1/4	20
36" Length	37 1/2	9 1/2	38	19 1/2	33 3/4	28 1/2
UBAF min	42 1/4	10 3/4	-	-	-	-
UBAF max	69 1/4	18	-	-	-	-
<b>8 INCH Ø</b>						
NO LENGTH	3 3/4	1/2	8 1/4	2 1/4	9 3/4	4
5" Length	7 1/2	1 1/2	11 3/4	4 1/4	12 1/2	7
6" Slip Length	7 1/2	1 1/2	-	-	-	-
12" Length	14 1/4	3 1/4	17 3/4	7 3/4	17 1/2	11 3/4
18" Length	20	4 3/4	23	10 3/4	21 3/4	16
24" Length	26	6 1/2	28 1/4	13 3/4	26	20 1/4
36" Length	37 1/2	9 1/2	38 1/2	19 3/4	34 1/2	28 3/4
UBAF min	42 1/4	10 3/4	-	-	-	-
UBAF max	69 1/4	18	-	-	-	-

All measurements are in inches

Use this table if you are installing an adjustable length between the elbows.

LENGTH BETWEEN OFFSETS	15° Elbows		30° Elbows		45° Elbows	
	RISE	OFFSET	RISE	OFFSET	RISE	OFFSET
<b>6 INCH Ø</b>						
NO LENGTH + UB6SF	7 1/2 - 7 1/2	1 1/2 - 1 1/2	8 1/4 - 10 1/2	2 3/4 - 4	9 1/4 - 11	4 1/2 - 6 1/4
5" Length + UB6SF	8 3/4 - 11 1/2	1 3/4 - 2 1/2	11 3/4 - 14	4 3/4 - 6	12 - 14	7 1/4 - 9 1/4
5" Length + UB12SF	14 1/4 - 17 1/4	3 1/4 - 4	16 3/4 - 19 1/4	7 1/2 - 9	16 - 18 1/4	11 1/4 - 13 1/2
12" Length + UB12SF	15 1/2 - 24	3 1/2 - 6	17 3/4 - 25 1/4	8 1/4 - 12 1/2	17 - 23	12 1/4 - 18 1/4
18" Length + UB12SF	21 1/4 - 29 3/4	5 1/4 - 7 1/2	23 - 30 1/2	11 1/4 - 15 1/2	21 1/4 - 27 1/4	16 1/2 - 22 1/2
24" Length + UB18SF	27 - 41 1/4	6 3/4 - 10 1/2	28 1/4 - 41	14 1/4 - 21 1/2	25 1/2 - 35 3/4	20 3/4 - 31
UBAF	-	-	41 3/4 - 66	22 - 36	36 1/2 - 56 1/4	31 3/4 - 51 1/2
UBAF + 18" Length	-	-	55 1/2 - 79 3/4	30 - 44	47 3/4 - 67 3/4	43 - 63
UBAF min + UB6SF	43 1/2 - 46 1/4	11 1/4 - 11 3/4	-	-	-	-
UBAF min + UB18SF	43 1/2 - 57 3/4	11 1/4 - 15	-	-	-	-
UBAF max + UB18SF	70 1/2 - 84 3/4	18 1/2 - 22 1/4	-	-	-	-
36" + 36" + 12" + UB18SF	83 1/4 - 97 1/2	21 3/4 - 25 1/2	78 1/4 - 91 1/4	43 1/4 - 50 1/2	66 1/2 - 76 3/4	61 3/4 - 72
36" + 36" + 24" + UB18SF	94 3/4 - 109	24 3/4 - 28 3/4	88 3/4 - 101 1/2	49 1/4 - 56 1/2	75 - 85 1/4	70 1/4 - 80 1/2
36" + 36" + 36" + UB18SF	106 1/4 - 120 1/2	28 - 31 3/4	99 1/4 - 112	55 1/4 - 62 1/2	83 1/2 - 93 3/4	78 3/4 - 89
<b>7 INCH Ø</b>						
NO LENGTH + UB6SF	7 1/2 - 7 1/2	1 1/2 - 1 1/2	8 3/4 - 11	2 3/4 - 4	10 - 11 3/4	4 3/4 - 6 1/2
5" Length + UB6SF	8 3/4 - 11 1/2	1 3/4 - 2 1/2	12 1/4 - 14 1/2	4 3/4 - 6	12 3/4 - 14 3/4	7 1/2 - 9 1/2
5" Length + UB12SF	14 1/4 - 17 1/4	3 1/4 - 4	17 1/4 - 19 3/4	7 1/2 - 9	16 3/4 - 19	7 1/2 - 13 3/4
12" Length + UB12SF	15 1/2 - 24	3 1/2 - 6	18 1/4 - 25 3/4	8 1/4 - 12 1/2	17 3/4 - 23 3/4	12 1/2 - 18 1/2
18" Length + UB12SF	21 1/4 - 29 3/4	5 1/4 - 7 1/2	23 1/2 - 31	11 1/4 - 15 1/2	22 - 28	16 3/4 - 22 3/4
24" Length + UB18SF	27 - 41 1/4	6 3/4 - 10 1/2	28 3/4 - 41 1/2	14 1/4 - 21 1/2	26 1/4 - 36 1/2	21 - 31 1/4
UBAF	-	-	42 1/4 - 66 1/2	22 - 36	37 1/4 - 57	32 - 51 3/4
UBAF + 18" Length	-	-	56 - 80 1/4	30 - 44	48 1/2 - 68 1/2	43 1/4 - 63 1/4
UBAF min + UB6SF	43 1/2 - 46 1/4	11 1/4 - 11 3/4	-	-	-	-
UBAF min + UB18SF	43 1/2 - 57 3/4	11 1/4 - 15	-	-	-	-
UBAF max + UB18SF	70 1/2 - 84 3/4	18 1/2 - 22 1/4	-	-	-	-
36" + 36" + 12" + UB18SF	83 1/4 - 97 1/2	21 3/4 - 25 1/2	78 3/4 - 91 3/4	43 1/4 - 50 1/2	67 1/4 - 77 1/2	62 - 72 1/4
36" + 36" + 24" + UB18SF	94 3/4 - 109	24 3/4 - 28 3/4	89 1/4 - 102	49 1/4 - 56 1/2	75 3/4 - 86	70 1/2 - 80 3/4
36" + 36" + 36" + UB18SF	106 1/4 - 120 1/2	28 - 31 3/4	99 3/4 - 112 1/2	55 1/4 - 62 1/2	84 1/4 - 94 1/2	79 - 89 1/4
<b>8 INCH Ø</b>						
NO LENGTH + UB6SF	7 1/2 - 7 1/2	1 1/2 - 1 1/2	9 1/4 - 11 3/4	3 - 4 1/4	10 1/2 - 12 1/2	5 - 7
5" Length + UB6SF	8 3/4 - 11 1/2	1 3/4 - 2 1/2	12 3/4 - 15 1/4	5 - 6 1/4	13 1/2 - 15 1/4	7 3/4 - 9 3/4
5" Length + UB12SF	14 1/4 - 17 1/4	3 1/4 - 4	17 3/4 - 20 1/4	7 3/4 - 9 1/4	17 1/2 - 19 1/2	7 3/4 - 14
12" Length + UB12SF	15 1/2 - 24	3 1/2 - 6	18 3/4 - 26 1/2	8 1/2 - 12 3/4	18 1/4 - 24 1/2	12 3/4 - 19
18" Length + UB12SF	21 1/4 - 29 3/4	5 1/4 - 7 1/2	24 - 31 3/4	11 1/2 - 15 3/4	22 1/2 - 28 3/4	17 - 23 1/4
24" Length + UB18SF	27 - 41 1/4	6 3/4 - 10 1/2	29 1/4 - 42	14 1/2 - 21 3/4	26 3/4 - 37 1/4	21 1/4 - 31 3/4
UBAF	-	-	43 - 67 1/4	22 1/4 - 36 1/4	38 - 57 3/4	32 1/4 - 52 1/4
UBAF + 18" Length	-	-	56 3/4 - 81	30 1/4 - 44 1/4	49 1/4 - 69	43 3/4 - 63 1/2
UBAF min + UB6SF	43 1/2 - 46 1/4	11 1/4 - 11 3/4	-	-	-	-
UBAF min + UB18SF	43 1/2 - 57 3/4	11 1/4 - 15	-	-	-	-
UBAF max + UB18SF	70 1/2 - 84 3/4	18 1/2 - 22 1/4	-	-	-	-
36" + 36" + 12" + UB18SF	83 1/4 - 97 1/2	21 3/4 - 25 1/2	79 1/2 - 92 1/4	43 1/2 - 50 3/4	67 3/4 - 78 1/4	62 1/4 - 72 3/4
36" + 36" + 24" + UB18SF	94 3/4 - 109	24 3/4 - 28 3/4	89 3/4 - 102 3/4	49 1/2 - 56 3/4	76 1/4 - 86 3/4	70 3/4 - 81 1/4
36" + 36" + 36" + UB18SF	106 1/4 - 120 1/2	28 - 31 3/4	100 1/4 - 113	55 1/2 - 62 3/4	84 3/4 - 95 1/4	79 1/4 - 89 1/2

All measurements are in inches