

EXCELPrime

SINGLE WALL STOVE PIPE



EXCELPrime Technical Information

Certification

EXCELPrime has been tested and listed by Intertek Testing Services

Applications

EXCELPrime is designed to be used as a connector between a freestanding oil, wood or coal burning stove and a masonry or metal chimney.

Allowable Flue Gas Temperatures

Max Continuous	650°C (1200°F)
Brief Forced Firing	925°C (1700°F)
Tested To	1150°C (2100°F)

Clearance to Combustible Materials

EXCELPrime is certified for 18" clearance to combustible materials or otherwise specified by appliance manufacturer instructions.

With the addition of a listed EXCELPrime Heat Shield, the clearance can be reduced to:

6" dia.	- 4" clearance from the shield
7" & 8" dia.	- 6" clearance from the shield

Construction

Single Wall: 24ga steel

Seam: Laser seam welded

Paint: Forrest "Stove Bright" flat black

EXCELPrime Engineering and Design Considerations

Maximum allowable overall height:

EXCELPrime must not exceed 10 feet in length and a maximum of two 90-degree elbows are permitted.

To assemble EXCELPrime, ensure that the shrunken end is facing down. Place one length on top of another and screw them together using the screws provided. There is no cutting required and all the screw holes are predrilled. EXCELPrime easily fits most stoves including cast iron stoves and stoves with oval collars.

EXCELPrime

Single wall stove pipe with smooth, clean lines.

- Heavy wall, 24ga steel.
- Laser welded to be perfectly round and does not require assembly like snap lock pipes.
- Has a 5 year, no questions asked replacement warranty.
- Without shielding, EXCELPrime requires 18" clearance to combustibles in all diameters.
- With an EXCELPrime UL Listed Heat Shield, clearance to combustibles can be reduced to 4" from the exterior of the shield for 6" EXCELPrime or 6" clearance for 7 & 8" EXCELPrime.



Length (SW1, SW18, SW2, SW3, SW4)

Slip Length (SW1S)

Adjustable Length (SWA)

Lengths are available in 12", 18", 24", 36" and 48" lengths; 6", 7" and 8" diameter.

Slip Length will slide into a regular straight length allowing you to adjust the overall length of a straight run without cutting. The minimum adjustment can be reached only if the length used below the slip length is long enough to accept it.

Adjustable Lengths combine a 36" length and a 36" slip length in one box. The SWA provides enough range that it is often the only component required for vertical installations.

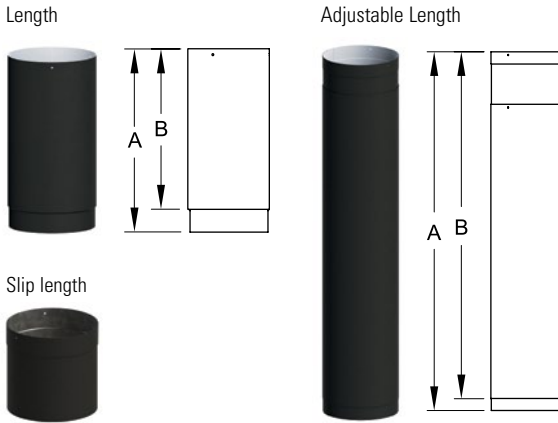

INCHES

Length Dimensions		
Code	A	B
SW1	12	10 5/8
SW18	18	16 5/8
SW2	24	22 5/8
SW3	36	34 5/8
SW4	48	46 5/8

INCHES

Slip Length Dimensions		
Code	Min. Installed Length	Max. Installed Length
SW1S	1 3/8	10 5/8
SW6S	1 3/8	4 5/8

INCHES

Adjustable Length Dimensions				
Code	A MIN.	A MAX.	B MIN.	B MAX.
SWA	40	68	38 5/8	66 5/8

Damper Section (SWD)

Acts as a 5" length and has a butterfly type incorporated damper. In the closed position, the damper is still 20% open so as not to completely block the chimney.

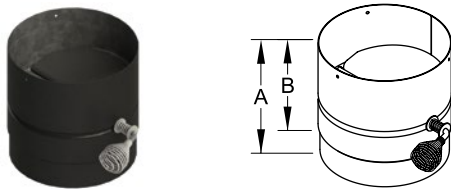

INCHES

Dimensions		
Code	A	B
SWD	6	4 5/8

Tee (SWT)

Combines a 90° transition with a clean out. Tee Cap (SWTP) **not included**.

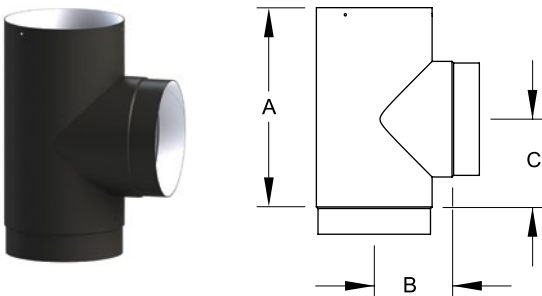

INCHES

Dimensions			
Code	A	B	C
6SWT	10 5/8	4 1/4	4 3/4
7SWT	10 5/8	4 3/4	4 3/4
8SWT	10 5/8	5 1/4	4 3/4

Tee Cap (SWTP)

Caps off the open portion of a Tee.



INCHES

Dimensions		
Code	A	B
6SWTP	6	1
7SWTP	7	1
8SWTP	8	1

Elbow

(SW45, SW90)

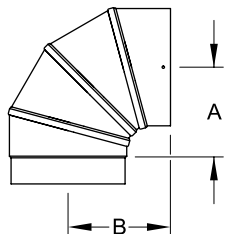
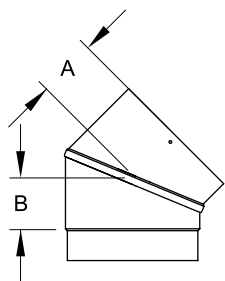

Are available in 45° and 90°

INCHES

Dimensions		
Code	A	B
6SW45	2 5/8	2 1/4
7SW45	2 7/8	2 1/4
8SW45	3 1/8	2 1/2
6SW90	4 3/4	5 3/8
7SW90	5 1/4	5 7/8
8SW90	5 3/4	6 3/8

Slip Elbow 90°

(SW90S)

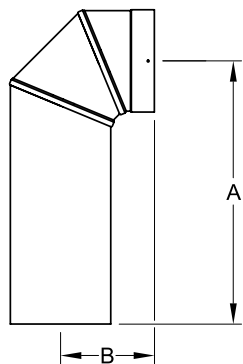

Combines a 90° elbow and a slip length in one piece.

INCHES

Dimensions			
Code	A max.	A min.	B
6SW90S	19 3/4	4	5 5/8
7SW90S	19 3/8	4 1/2	6 1/8
8SW90S	19 1/8	5	6 5/8

Clean Out Elbow 90°

(SW90C)

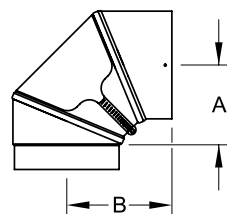

Incorporates an easily removable inspection port that is large enough for a chimney brush.

INCHES

Dimensions		
Code	A	B
6SW90C	4 5/8	6
7SW90C	5 1/8	6 1/2
8SW90C	5 5/8	7

Adjustable Elbow 90°

(SWA90)

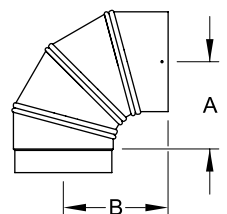

The angle of this elbow is variable between 90° and straight. Patent Pending.

INCHES

Dimensions		
Code	A	B
6SWA90	5 3/8	6 3/8
7SWA90	5 7/8	6 7/8
8SWA90	6 3/8	7 3/8

Increaser (SWSI)

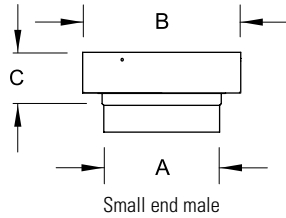

Designed to increase the diameter of a system to accommodate a range of flue sizes, appliances and installations. *Note: Increasing chimney diameter can reduce draft and increase creosote formation. Be careful to use these components only when appropriate.*

INCHES

Dimensions			
Code	A	B	C
SWSI67	6	7 1/8	2 5/8
SWSI68	6	8 1/8	2 5/8
SWSI46	3 7/8	6 1/8	2 1/4

Reducer (SWSR)

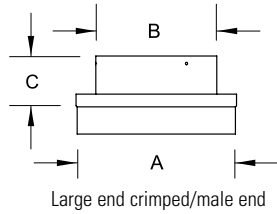

Designed to reduce the diameter of a system to accommodate a range of flue sizes, appliances and installations. *Note: Decreasing chimney diameter even 1" can have a serious negative impact on chimney performance. Be careful to use these components only when appropriate.*

INCHES

Dimensions			
Code	A	B	C
SWSR76	7	6 1/8	2 1/2
SWSR87	8	7 1/8	2 1/2
SWSR86	8	6 1/8	2 1/2

Oval to Round Adapter (8SWOR)

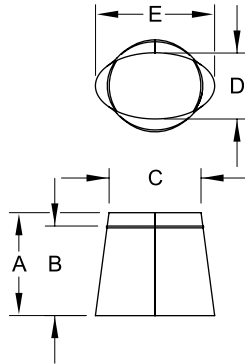

Connects EXCELPrime to stoves with oval flue collars. Available in 8" only.

INCHES

Dimensions					
Code	A	B	C	D	E
8SWOR	9	7 7/8	8	5 3/4	10 3/8

12" Slip Flue Extension (6SWEX)

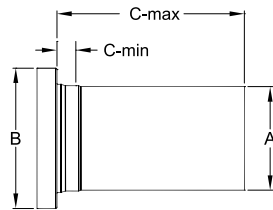

Can be used to replace the EXCEL Flue Extension (EX) in EXCELPrime installations. This 12" long version will slip into a standard length, eliminating the need for a slip length.

INCHES

Dimensions				
Code	A	B	C MIN.	C MAX.
6SWEX	5 7/8	8	1/2	10 - 3/4

Barometric Damper Adapter (SWBA)

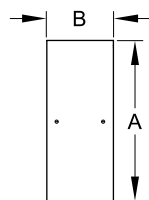

This adapter simplifies the connection between a barometric damper and an EXCELPrime or ULTRABlack tee.

INCHES

Dimensions		
Code	A	B
6SWBA	6 1/16	2 3/8
7SWBA	7 1/16	2 3/8
8SWBA	8 1/16	2 3/8

Masonry Adapter

(SWM)

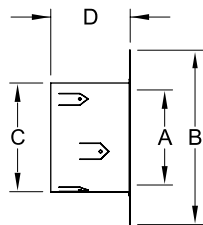
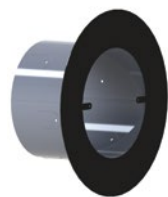

Connects 6" EXCELPrime to a 7" or 8" masonry chimney thimble. *Note: EXCELPrime is not certified to pass through a combustible wall. An EXCELiner Insulated Thimble (ITH, page 41) must be used where there is a combustible wall between the stove and the masonry chimney.*

Dimensions				
Code	A	B	C	D
6SWM	6 1/4	10 1/2	6 5/8	4 3/4

See 6UBM for use with 6" Masonry Chimney Thimbles

Masonry Plug

(SWMP)

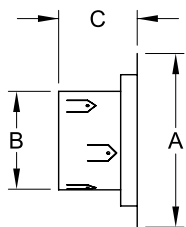
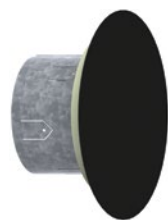

Plugs the opening into an existing masonry chimney that had been previously used to vent another appliance. The Masonry Plug is capable of plugging a round opening up to 8" diameter and is lined with insulation to prevent cold drafts.

Dimensions			
Code	A	B	C
SWMP	10 1/2	5 7/8	4 3/4

Heat Shield

(SW1HS, SW2HS, SW3HS, SW45HS, SW90HS)

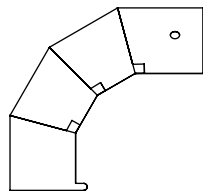
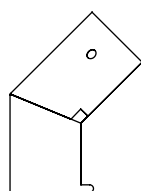
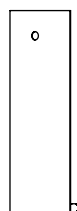

Reduces clearance required from combustible walls and ceilings. EXCELPrime heat shields are UL listed in combination with EXCELPrime only and will not reduce the clearance of other brands of stove pipe (each heatshield includes installed heatshield spacers). For other brands of single wall stove pipe, clearances will be reduced to those of an unlisted heat shield installation. Available in 12", 24", 36", 45° and 90° designs.

Clearance	
Diameter	Clearance to Combustibles from Shielding
6"	4"
7"	6"
8"	6"

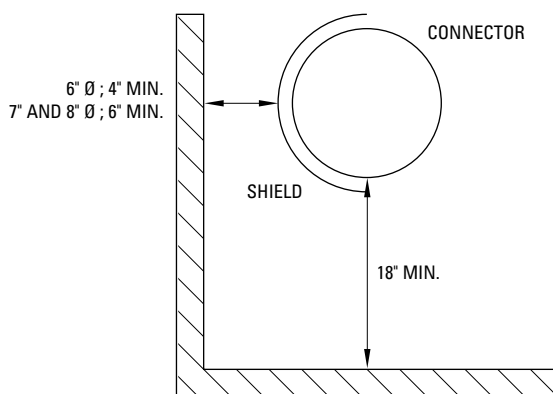

Heat Shield Spacer

(SWHSS)

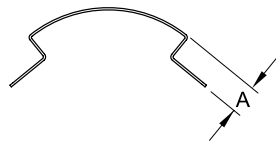

Used to maintain 7/8" spacing where shields do not overlap.

Dimensions	
Code	A
SWHSS	7/8

EXCELPrime Offset Tables

Use this table if you are not installing an adjustable length between the elbows.

LENGTH BETWEEN OFFSETS	45° Elbows	
	RISE	OFFSET
6 INCH Ø		
NO LENGTH	8 1/4	3 1/2
6" SLIP LENGTH	11 1/2	6 3/4
12" LENGTH	15 3/4	11
18" LENGTH	20	15 1/4
24" LENGTH	24 1/4	19 1/2
36" LENGTH	32 3/4	28
SWA min	35 3/4	30 3/4
SWA max	55 1/2	50 1/2
7 INCH Ø		
NO LENGTH	8 3/4	3 1/2
6" SLIP LENGTH	12	7
12" LENGTH	16 1/4	11 1/4
18" LENGTH	20 1/2	15 1/2
24" LENGTH	24 3/4	19 1/2
36" LENGTH	33 1/4	28
SWA min	36	31
SWA max	55 3/4	50 3/4
8 INCH Ø		
NO LENGTH	9 1/2	4
6" SLIP LENGTH MAX	12 3/4	7 1/4
12" LENGTH	17	11 1/2
18" LENGTH	21 1/4	15 3/4
24" LENGTH	25 1/2	20
36" LENGTH	34	28 1/2
SWA min	37	31 1/4
SWA max	56 3/4	51

All measurements are in inches

Use this table if you are installing an adjustable length between the elbows.

LENGTH BETWEEN OFFSETS	45° Elbows	
	RISE	OFFSET
6 INCH Ø		
NO LENGTH + L6S	- 11 1/2	- 6 3/4
12" LENGTH + L6S	16 3/4 - 19	12 - 14 1/4
12" LENGTH + L12S	- 23 1/4	- 18 1/2
18" LENGTH + L12S	21 - 27 1/2	16 1/4 - 22 3/4
24" LENGTH + L12S	25 1/4 - 31 3/4	20 1/2 - 27
18" + 12" LENGTH + L12S	28 1/2 - 35	23 3/4 - 30 1/4
36" LENGTH + L12S	33 3/4 - 40 1/4	29 - 35 1/2
SWA	36 1/2 - 55 1/2	31 3/4 - 50 1/2
7 INCH Ø		
NO LENGTH + L6S	- 12	- 7
12" LENGTH + L6S	17 1/4 - 19 1/2	12 - 14 1/2
12" LENGTH + L12S	- 23 3/4	- 18 3/4
18" LENGTH + L12S	21 1/2 - 28	16 1/4 - 23
24" LENGTH + L12S	25 3/4 - 32 1/4	20 1/2 - 27 1/4
18" + 12" LENGTH + L12S	29 - 35 1/2	23 3/4 - 30 1/2
36" LENGTH + L12S	34 1/4 - 40 3/4	29 - 35 1/2
SWA	37 - 55 3/4	32 - 50 3/4
8 INCH Ø		
NO LENGTH + L6S	- 12 3/4	- 7 1/4
12" LENGTH + L6S	18 - 20 1/2	12 1/2 - 14 3/4
12" LENGTH + L12S	- 24 3/4	- 19
18" LENGTH + L12S	22 1/4 - 28 3/4	16 3/4 - 23 1/4
24" LENGTH + L12S	26 1/2 - 33	21 - 27 1/2
18" + 12" LENGTH + L12S	29 3/4 - 36 1/2	24 1/4 - 30 3/4
36" LENGTH + L12S	35 - 41 1/2	29 1/2 - 36
SWA	38 - 56 3/4	32 1/4 - 51

All measurements are in inches