

ER-RA1201
Andrion (2)
Chenet (2)

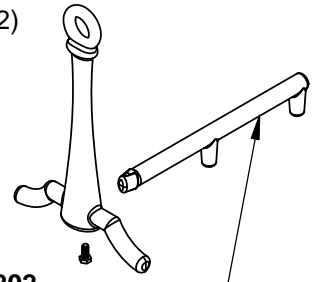

ER-RA1202
Andrion Back Leg
Patte arrière de chenet

ER-RA0923
Guillotine Door Removable Handle
Poignée amovible de la porte guillotine

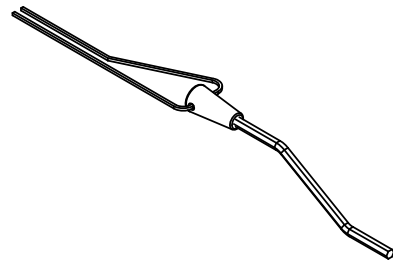

FR-14.17.85
High Temperature Grease
Graisse haute température

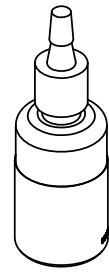

ER-RA0918
Left Counterweight Cover
Couvercle de contrepoind gauche

ER-RA1117
Firebox Insulation Assembly
Ensemble d'isolant de la boîte à feu

ER-RA0937
Guide Rail Assembly
Ensemble de rail guide

EO-RB1000
Refractory Bricks Assembly
Ensemble de pierres réfractaires

ER-RA0602
Upper Front Finishing Cover
Plaque de finition avant supérieure

ER-RA0934
Firescreen Rail Left
Rail de pare-étincelles gauche

ER-RA0601
Top Finishing Cover
Revêtement de finition du dessus

ER-RA0603
Front Finishing Cover
Plaque de finition avant

ER-RA0604
Left Finishing Cover
Revêtement de finition gauche

ER-RA0606
Front Counterweight Cover
Plaque pour insertion des contrepoinds

ER-RA0924
Black Lintels (3)
Linteaux noirs (3)

ER-RA0609
Lower Front Finishing Cover
Revêtement de finition avant inférieur

ER-RA0605
Right Finishing Cover
Revêtement de finition droit

ER-RA0933
Firescreen
Pare-Étincelles

ER-RA0929
Complete Glass Door
Porte vitrée assemblée

ER-RA0939
Counterweight Cable
Câble de contrepoinds

ER-RA0935
Firescreen Rail Right
Rail de pare-étincelles droit

ER-RA0916
Firescreen Handle
Poignée pare-étincelles

ER-RA1148
Hearth Threshold
Seuil de l'âtre

ER-RA0919
Right Counterweight Cover
Couvercle de contrepoind droit

Or / Ou

EO-VP1000
Vermiculite Panels Assembly
Ensemble de panneaux de vermiculite



RUMFORD 1000B



DATE	REV.
2016-09-02	01

ER-RA0938
Firescreen Counterweight
Contrepoids du pare-étincelles

ER-RA0903
Counterweight
Felt (4)
Feutre pour
contrepois (4)

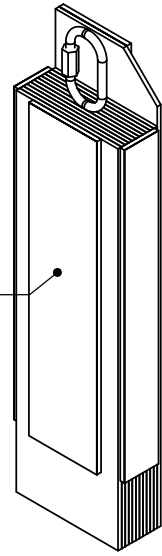

ER-RA0901
Door Counterweight
Contrepoids porte

ER-RA0903
Counterweight
Felt (4)
Feutre pour
contrepois (4)

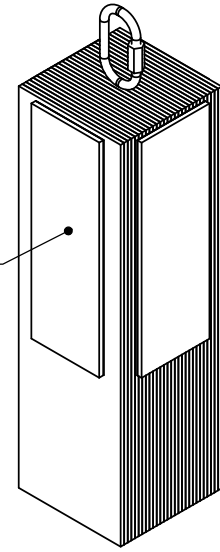

ER-RA0939
Counterweight cable
Câble de contrepois



ER-RA0501
Outside air control
Contrôle d'air extérieur

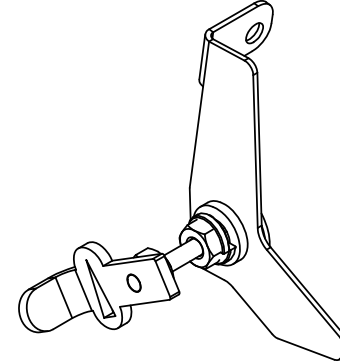

ER-RA0502
Outside air control cable
Câble pour contrôle d'air
extérieur

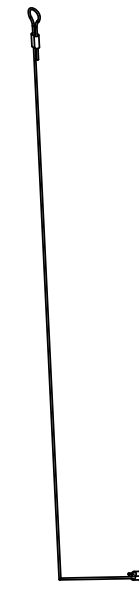

ER-RA0928
Glass Door Latch
Loquet de porte vitrée

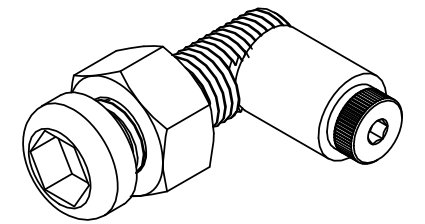

ER-RA0921
Left Pulley Support and cable
Support de poulie gauche et câble

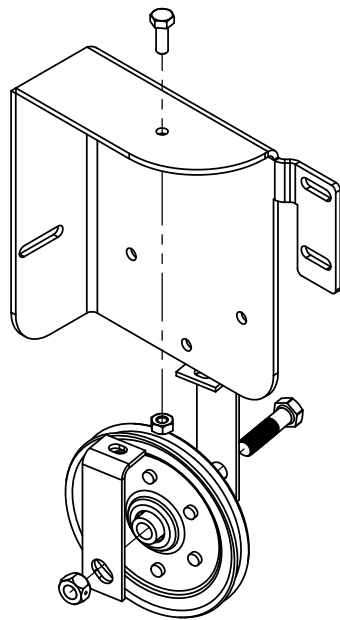

ER-RA0942
Right Pulleys Support and cable
Support de poulies droit et câble

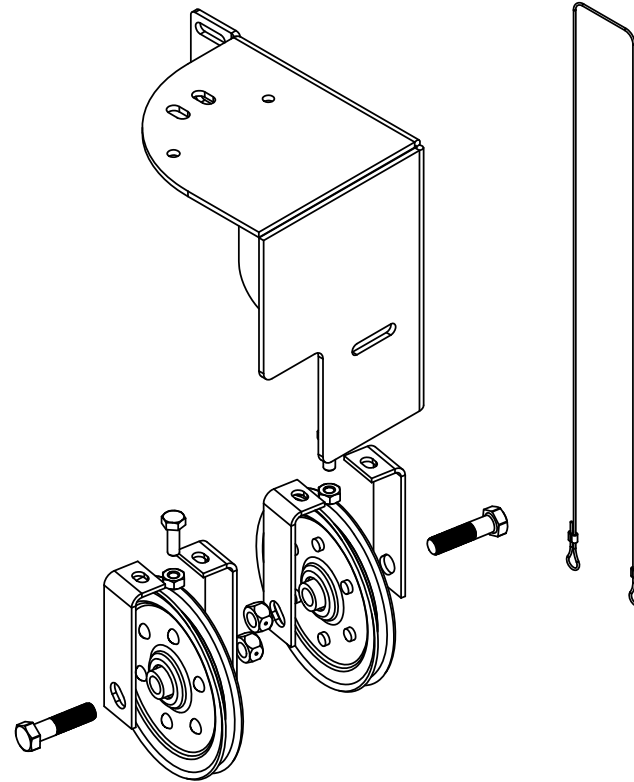

ER-RA0911
Guillotine Door Frame
Cadre de la porte guillotine

ER-RA0941
Door Frame Top Cover
Plaque de finition pour
cadrage de porte

ER-RA0920
Black Cap (4)
Capuchon
noir (4)

ER-RA0910
Bottom Stainless Steel Gasket
Joint d'étanchéité inférieur en inox

ER-RA0909
Top Stainless
Steel Gasket
Joint d'étanchéité
supérieur en inox

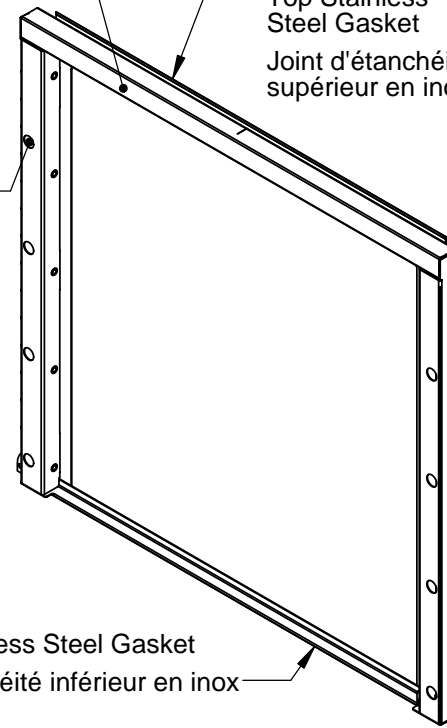

ER-RA0929
Complete Glass Door
Porte vitrée assemblée

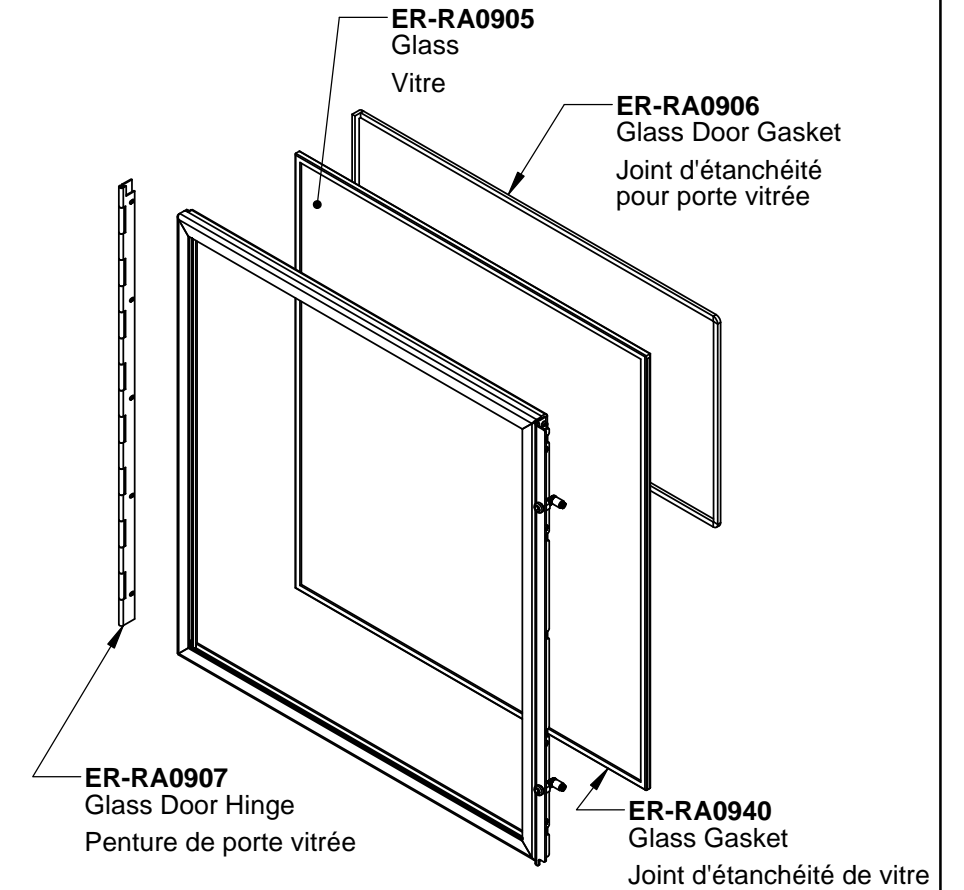

#	Code	Qty/Qté
1	ER-RA1109	1
4	ER-RA1130	1
5	ER-RA1131	2
6	ER-RA1132	6
7	ER-RA1133	2
8	ER-RA1134	2
9	ER-RA1135	3
10	ER-RA1136	4
11	ER-RA1137	1
12	ER-RA1138	1
13	ER-RA1139	1
14	ER-RA1128	2
15	ER-RA1127	2
16	ER-RA1140	1
17	ER-RA1141	2
18	ER-RA1142	1
19	ER-RA1143	2
20	ER-RA1144	1
21	ER-RA1145	1
22	ER-RA1146	1
23	ER-RA1147	1

EO-RB1000B
Refractory Bricks Assembly (Cement)
Ensemble de pierres réfractaires (Ciment)

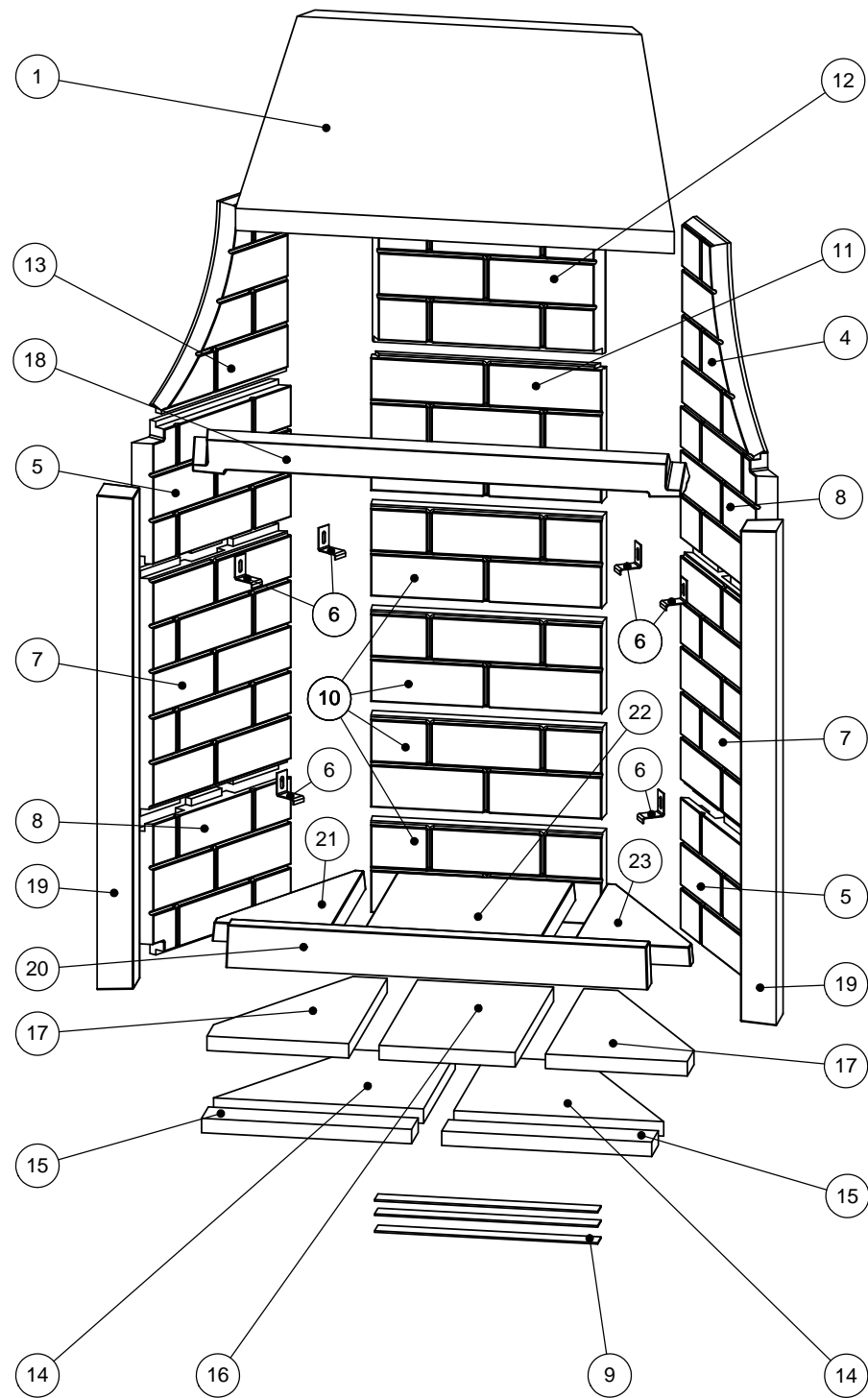

#	Code	Qty/Qté
1	ER-RA1109	1
3	ER-RA1122	1
4	ER-RA1121	1
5	ER-RA1120	1
6	ER-RA1119	1
7	ER-RA1118	1
8	ER-RA1124	1
9	ER-RA1123	1
10	ER-RA1103	1
11	ER-RA1107	1
12	ER-RA1108	1
13	ER-RA1128	2
14	ER-RA1127	2
15	ER-RA1102	1
16	ER-RA1126	2
17	ER-RA1125	1
18	ER-RA1151	2
19	ER-RA1150	2

EO-VP1000
Refractory Bricks Assembly (Vermiculite)
Ensemble de pierres réfractaires (Vermiculite)

